



Sağım Sistemi Parçaları & Hayvancılık Ekipmanları  
Milking System Parts & Livestock Equipment

## Yedek Parça Kataloğu Spare Parts Catalog



Öncel ile Öncelikli olun  
Be Privileged With Öncel



Öncel Sağım Parçaları ve Hayvancılıkta kullanılan tüm yedek parça ve ekipmanlarını bu katalog içeriğinde bulabilirsiniz.

All spare parts and equipment we manufacture are in this catalog.



**Öncel**<sup>®</sup> ile  
öncelikli olun  
**Çünkü Siz,**  
buna değersiniz



Be Privileged with



Because You,  
deserve it

[www.oncelmak.com](http://www.oncelmak.com)





Öncel Makina olarak 2003 yılında Memet ÖNCEL tarafından kurulduk ve oğlu Remzi ÖNCEL tarafından ÖNCEL MAKİNA Ltd. Şti. resmi adıyla devam etmekteyiz. Süt sağım makinalarının ve sağım sistemlerinin yedek parçalarını ve hayvancılık ekipmanlarını, gün geçtikçe gelişen, değişen sektörün ihtiyaçlarına ve gıdaya uygun hammaddeler kullanarak üretmekteyiz.

Türkiye'nin dört bir yanında satış noktalarımız ve yurtdışında birçok ülkeye ihracatımız mevcuttur. Ayrıca müşterilerimizin ihtiyaç ve beklentilerini anlamak, müşterilerimize kaliteli ürün ve hizmetler sunmak ve müşterilerimizin en değerli tedarikçisi kalmak için servis araçlarımız hizmetinizdedir. Bu sayede Türk Çiftçisi tarafından ve yurtdışında hem marka olarak hem de kaliteden taviz vermeyen bir firma olarak kabul gördüğümüzü bu sektörde Türkiye Pazarı'nın %80'ini alarak ve birçok ülkeye ihracat yaparak kanıtladık.

Kuruluşumuzdan bu yana her zaman yeniliğe açık, yenilikleri takip eden ve ürün yelpazesine yenilerini ekleyen bir firmayız. Periyodik sürelerle düzenlediğimiz yurtiçi ve yurtdışı bayi ziyaretlerimizle müşterilerimizin beklenti ve görüşlerini alarak, teknoloji konusunda yenilikleri titizlikle takip etmeye, gün geçtikçe artan modern üretim tezgâhlarımızda ve büyüyen fabrikamızda, kalifiye elemanlarımızla en iyi ve kaliteli üretimi gerçekleştirmeye devam edeceğiz.

Öncel ile öncelikli olun çünkü siz buna değersiniz...

### **Neden Öncel Makina?**

#### **Yenilikçilik**

Kuruluşumuzdan bu yana her zaman yeniliğe açık, yenilikleri takip eden ve ürün yelpazesine yenilerini ekleyen bir firmayız.

### **Şatış Noktası Ağı**

Türkiye'nin dört bir yanında satış noktalarımız ve yurtdışında 30'dan fazla ülkeye ihracatımız mevcuttur. Ayrıca müşterilerimizin ihtiyaç ve beklentilerini anlamak, müşterilerimize kaliteli ürün ve hizmetler sunmak ve müşterilerimizin en değerli tedarikçisi kalmak için servis araçlarımız hizmetinizdedir.

### **Müşteri Portföyü**

Türk Çiftçisi tarafından ve yurtdışında hem marka olarak hem de kaliteden taviz vermeyen bir firma olarak kabul gördüğümüz bu sektörde Türkiye Pazarı'nın %80'inin alarak ve birçok ülkeye ihracat yaparak kalitemizi kanıtladık.



Founded in 2003 by Mr.Mehmet Oncel as "Oncel Makina", today a family business, based at Mustafakemalpasha, Bursa, is ran by Mr. Mehmet's son Mr.Remzi Oncel as "Oncel Makina San. ve Tic. Ltd. Sti."

Oncel Makina manufactures mobile milking machines, milking system parts and livestock equipment for cows, goats and sheep. All of our products are made of food grade raw materials.

Oncel Makina is proud to inform you about the care and responsibility the company shows in order to endure the fruitful collaboration with its highly esteemed customers and partners. During 15 years of Oncel Makina's functioning the company manufactures and delivers complete and high quality milking machines and spare parts.

**ISO 9001:2015**  
**KALİTE YÖNETİM SİSTEMİ**



### **Why Oncel?**

#### **Innovation**

We are a company which is open to innovation , which follows to innovations and which is adding the new products to it's product range.

### **Business Network**

We have sale points in every city of Turkey and we are exporting many foreign countries. Also for understanding to expectations and needs of our customers, for providing quality products and services to our customers and for remaning as most esteemed supplier of our customers, our service vehicles are at your service.

### **Portfolio**

Thus, in this sector by having %80 of Turkish Market and by exporting many countries, we proved our company in both domestic and overseas markets as a company which is a brand and as a company which does not compromise from the quality.

[www.oncelmak.com](http://www.oncelmak.com)



# İçindekiler / Index

- Süt Lastikleri / Milking Liners 1
- Hortumlar / Hoses 2
- Sağım Başlığı ve Aksesuarları / Milking Clusters and Accessories 3
- Pulsatörler /Pulsators 4
- Güğümler ve Aksesuarları / Buckets and Accessories 5
- Vakum Pompaları ve Aksesuarları / Vacuum Pumps and Accessories 6
- Sağım Sistemi Aksesuarları / Milking System Accessories 7
- Seyyar Makine Aksesuarları / Mobile Machine Accessories 8
- Çiftlik Ekipmanları /Livestock Equipment 9



# Süt Lastikleri / Milking liners

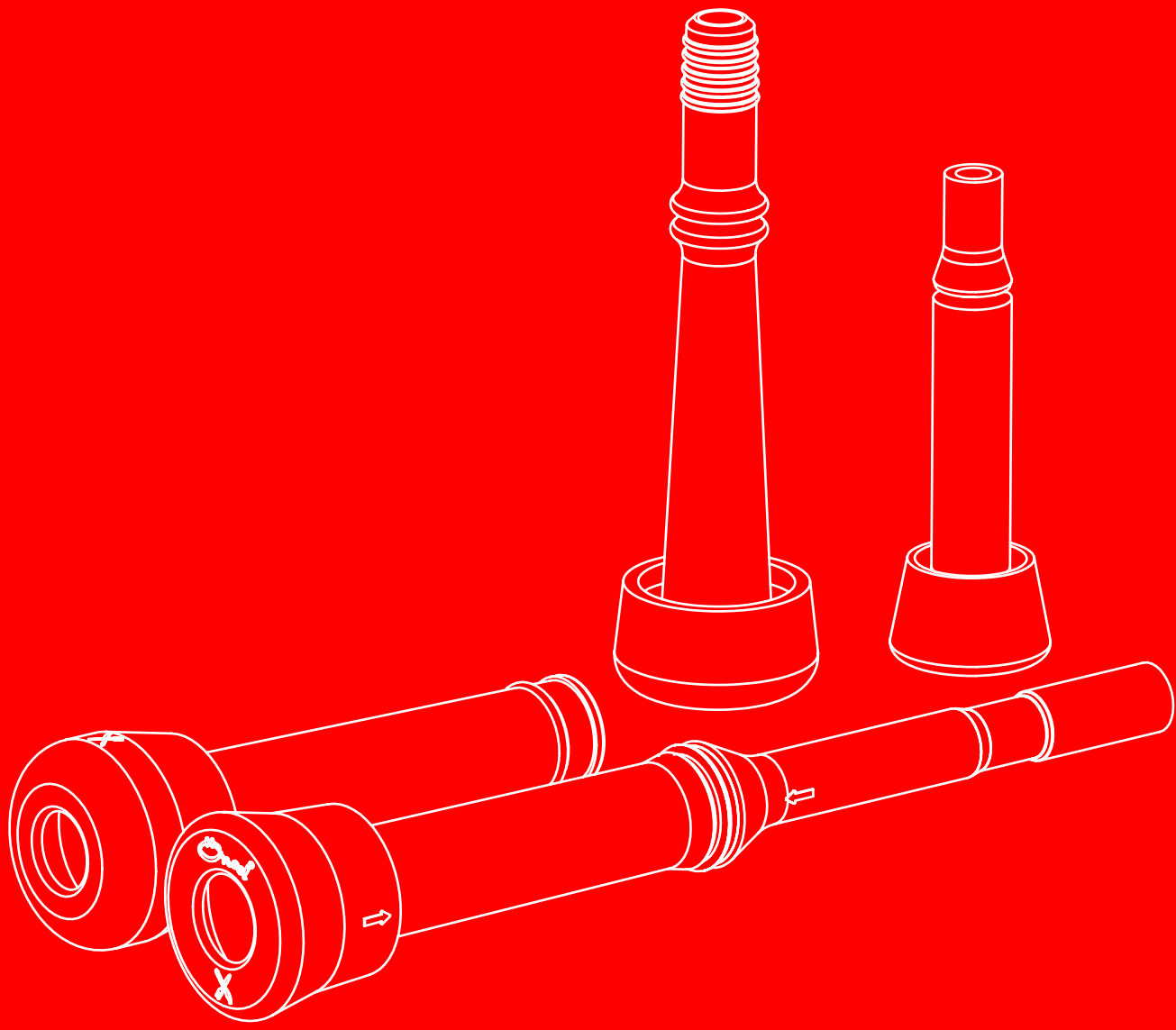





# İnsan ve Hayvan sağlığı için ; For milk quality and herd health;

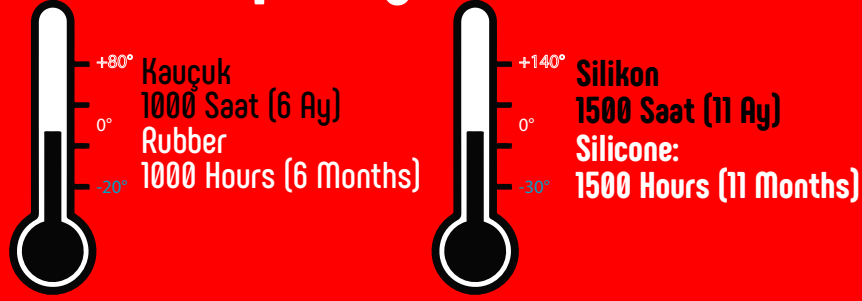

**Süt Lastiklerinizi Periyodik olarak Değiştiriniz...**  
**Change Milking Liners and Rubberware Regularly**

**Süt Lastiklerinin maruz bırakılmayacağı ortamlar;**  
**Please keep away milking liners from;**

-  **Güneş Işığı**  
**Direct Sunlight**
-  **Kesici Meteryaller**  
**Sharp Objects**
-  **Darbe**  
**Beware of Bumps**
-  **Yağ**  
**Oil**
-  **Aşırı Sıcak**  
**Hyper Heat**

**Oncel®**

**Yapılabilecek en iyi seçim...**  
**The Best Choice can be made...**

[www.oncelmak.com](http://www.oncelmak.com)

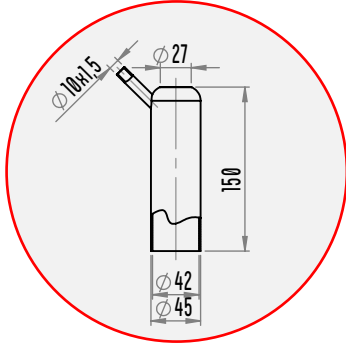

- Tüm Kısa Süt Lastiklerinde detayda bulunan kılıf kullanılmaktadır.
- Teat cup shells with the details shown in the chart are used with all short milking liners. (ÖC.027)

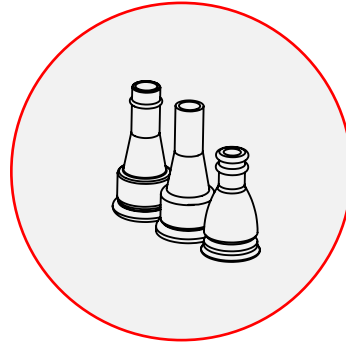

- Tüm Kısa Tip Memelik Lastiklerinde detayda bulunan, Süt Gözleme Camları kullanılmaktadır.
- Sight glasses shown in the picture are used with all short milking liners. (ÖC.031, ÖC.031-1, ÖC.032-1)

ÖC.001 Kauçuk Kısa Süt Lastiği - Short Rubber Milking Liner

ÖC.001/A Silikon Kısa Süt Lastiği - Short Silicone Milking Liner

ÖC.001/B Renkli Silikon Kısa Süt Lastiği - Colored Short Silicone Milking Liner



••• Opsiyonel İsteğe bağlı farklı renkte Üretilir.  
Silicon liner colors may vary according to order.

ÖC.002 Kauçuk Kısa Süt Lastiği - Short Rubber Milking Liner

ÖC.002/A Silikon Kısa Süt Lastiği - Silicone Short Milking Liner

ÖC.002/B Renkli Silikon Kısa Süt Lastiği - Colored Short Silicone Milking Liner



••• Opsiyonel İsteğe bağlı farklı renkte Üretilir.  
Silicon liner colors may vary according to order.

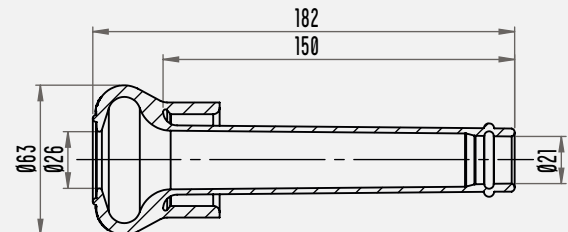
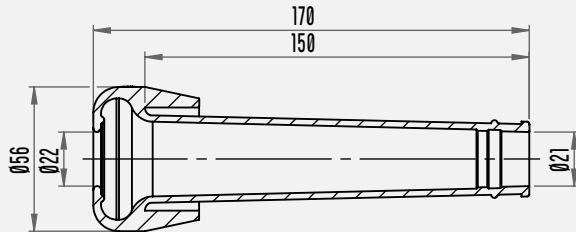



ÖC.002-2

Kauçuk Kısa Süt Lastiği - Short Rubber Milking Liner

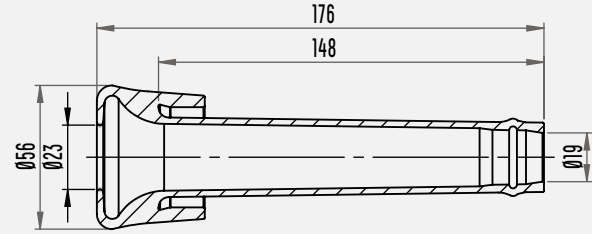

Kısa Süt Lastikleri Gıdaya Uygun Kauçuk hammaddeden , iklimsel koşullar dikkate alınarak, Steril olarak üretilmektedir. Kısa tip memelik lastikleri Süt Gözleme camları ile Paslanmaz Kılıflara monte edilmektedir. Sağım anında sütün görünmesi için tercih sebebidir.

Milking liners are made from high quality food-grade materials and have excellent swelling, hygiene and cow comfort properties. These type milking liners are assembled with special sight glasses and teat cup shells. Preferred for watching milk-flow during the milking procedure.



ÖC.004	Kauçuk Uzun Süt Lastiği - Long Rubber Milking Liner
ÖC.004-1	Silikon Uzun Süt Lastiği - Long Silicone Milking Liner
ÖC.004-1/A	Renkli Silikon Uzun Süt Lastiği - Colored Long Silicone Milking Liner
ÖC.004/B	Kauçuk Uzun Süt Lastiği - Long Rubber Milking Liner (Ø22)



●●●●● Renkli Silikon Ürünler, İsteğe bağlı Silikon Ürünler farklı renkte Üretilebilir.  
Silicon liner colors may vary according to order.

A	Ölçü/Dimension
Öc.004	Ø24
Öc.004-1	Ø24
Öc.004-1/A	Ø24
Öc.004/B	Ø22

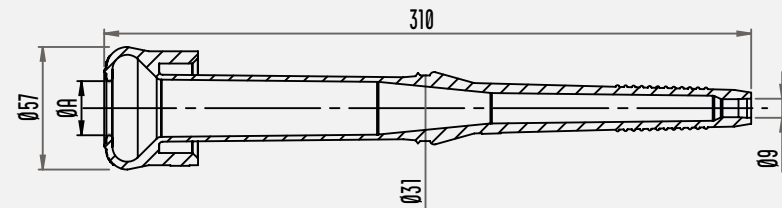

ÖC.004/A	Kauçuk Uzun Süt Lastiği - Long Rubber Milking Liner
ÖC.004-A/1	Silikon Uzun Süt Lastiği - Long Silicone Milking Liner
ÖC.004-B/2	Renkli Silikon Uzun Süt Lastiği - Colored Long Silicone Milking Liner



●●●●● Renkli Silikon Ürünler, İsteğe bağlı Silikon Ürünler farklı renkte Üretilebilir.  
Silicon liner colors may vary according to order.

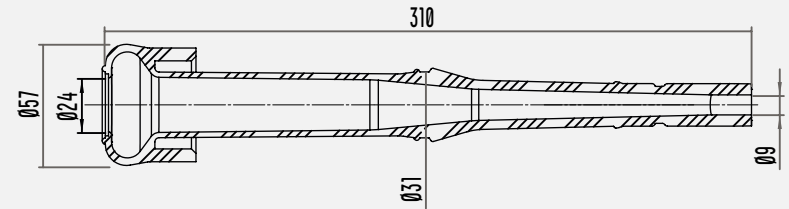

ÖC.005 Kaçuk Uzun Süt Lastiği - Long Rubber Milking Liner

ÖC.005/A Silikon Uzun Süt Lastiği - Long Silicone Milking Liner

ÖC.005/B Renkli Silikon Uzun Süt Lastiği - Colored Long Silicone Milking Liner



●●● Renkli Silikon Ürünler, İsteğe bağlı Silikon Ürünler farklı renkte Üretilebilir.  
Silicon liner colors may vary according to order.

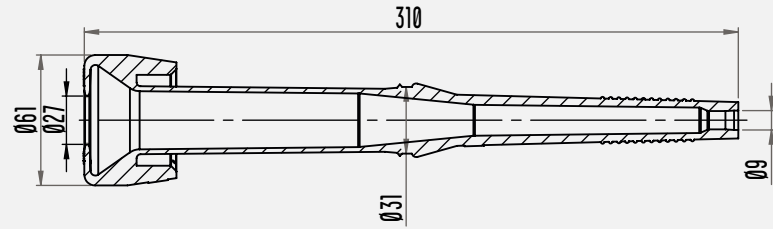

ÖC.005-1 Kaçuk Uzun Süt Lastiği - Long Rubber Milking Liner

ÖC.005-1/A Silikon Uzun Süt Lastiği - Long Silicone Milking Liner

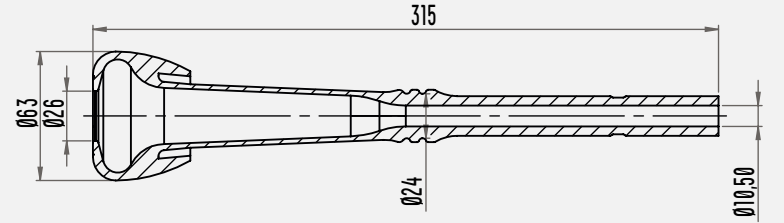

ÖC.006 Kaçuk Uzun Süt Lastiği - Long Rubber Milking Liner

ÖC.006/A Silikon Uzun Süt Lastiği - Long Silicone Milking Liner

ÖC.006/B Renkli Silikon Uzun Süt Lastiği - Colored Long Silicone Milking Liner



●●● Renkli Silikon Ürünler, İsteğe bağlı Silikon Ürünler farklı renkte Üretilebilir.  
Silicon liner colors may vary according to order.

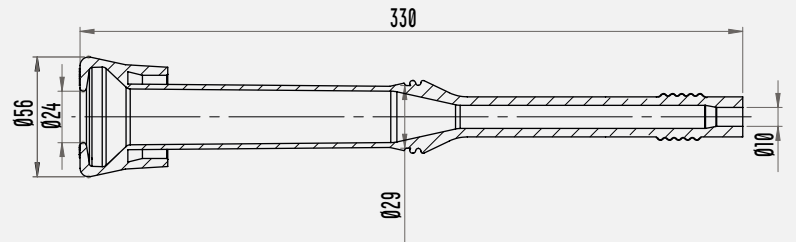

ÖC.006-1 Kauçuk Uzun Süt Lastiği - Long Rubber Milking Liner

ÖC.006-1/A Kauçuk Uzun Süt Lastiği (Düz) - Long Rubber Milking Liner (Flat)



ÖC.006-2 Kauçuk Uzun Süt Lastiği (Düz) - Long Rubber Milking Liner (Flat)

ÖC.006-2/A Renkli Silikon Uzun Süt Lastiği - Colored Long Silicone Milking Liner

ÖC.006-2/B Renkli Silikon Uzun Süt Lastiği (Düz) - Colored Long Silicone Milking Liner (Flat)

ÖC.006-2/C Silikon Uzun Süt Lastiği (Düz) - Long Silicone Milking Liner (Flat)



● ● ● İsteğe bağlı Silikon Ürünler farklı renkte Üretilir.  
Silicon liner colors may vary according to order.



ÖC.008 Kauçuk Uzun Süt Lastiği - Long Rubber Milking Liner

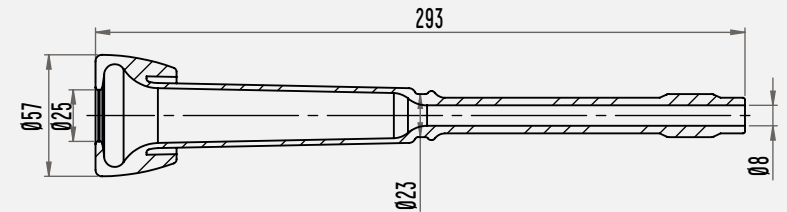
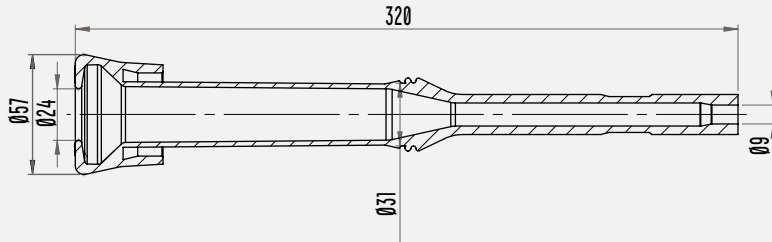

ÖC.008-1 Kauçuk Uzun Süt Lastiği - Long Rubber Milking Liners



● ● ● İsteğe bağlı Silikon Ürünler farklı renkte Üretilebilir.  
Silicon liner colors may vary according to order.

ÖC.008-2 Kauçuk Uzun Süt Lastiği - Long Rubber Milking Liners

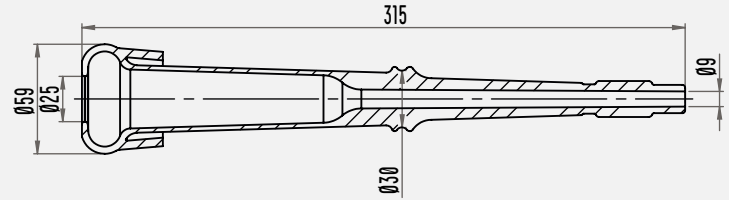
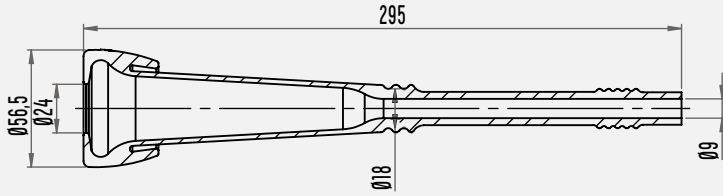

ÖC.L1108 Kauçuk Uzun Süt Lastiği - Long Rubber Milking Liner

ÖC.L1108/A Silikon Uzun Süt Lastiği - Long Silicone Milking Liner



●●●● İsteğe bağlı Silikon Ürünler farklı renkte Üretilir.  
Silicon liner colors may vary according to order.

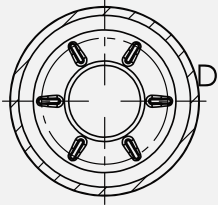
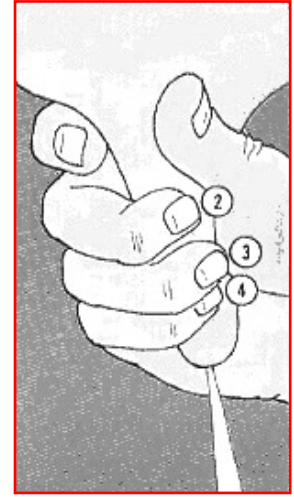
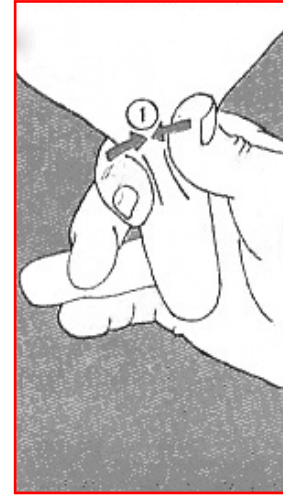

KESİT B-B

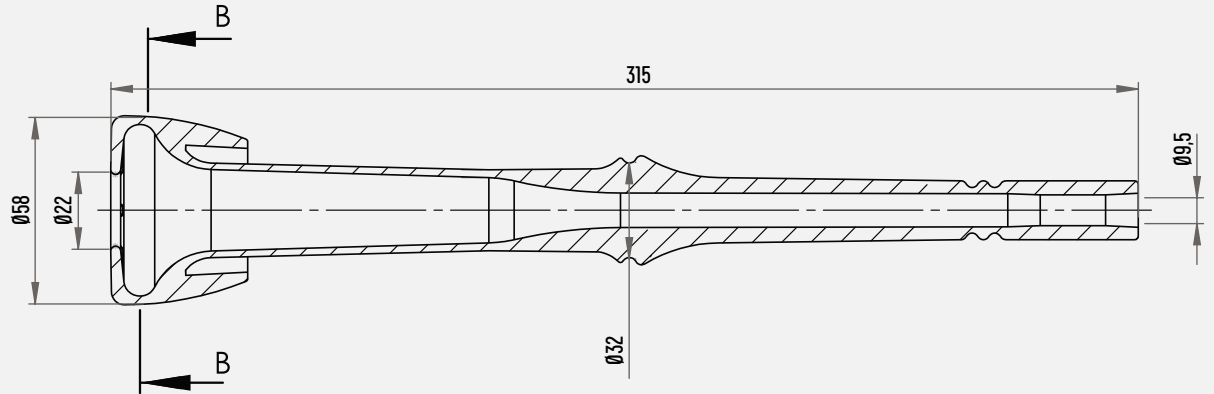

Ö L1108 ile sağılıyor, Fakat Sizi Hissediyor...

Geleneksel Sağım, Yenilikçi Yaklaşım, Daha Fazla Verim...

Hayvan Anatomisine uygun, Memeye zarar vermeyen,  
Sağımı başarılı yapabilecek tasarım, Doğru hammadde seçimi,  
Sağımdaki Ritmi Süt Lastiğine Öğrettik...

Your animal is milked with  
L1108 but she feels your hand...

We know how careful you are

Suitable for animal anatomy , does not hurt the teat ,  
best design for milking , correct choice for raw material .  
We taught the rhytme of milking to our liner  
Traditional milking , innovative and more yield





ÖC.138 Silikon Küçükbaş (Keçi) Süt Lastiği - Silicone Goat Milking Liner

ÖC.138-1 Kauçuk Küçükbaş (Keçi) Süt Lastiği - Rubber Goat Milking Liner



●●●● İsteğe bağlı Silikon Ürünler farklı renkte Üretilebilir.  
Silicon liner colors may vary according to order.

ÖC.170 Silikon Küçükbaş (Koyun) Süt Lastiği - Silicone Sheep Milking Liner

ÖC.170-1 Kauçuk Küçükbaş (Koyun) Süt Lastiği - Rubber Sheep Milking Liner



●●●● İsteğe bağlı Silikon Ürünler farklı renkte Üretilebilir.  
Silicon liner colors may vary according to order.

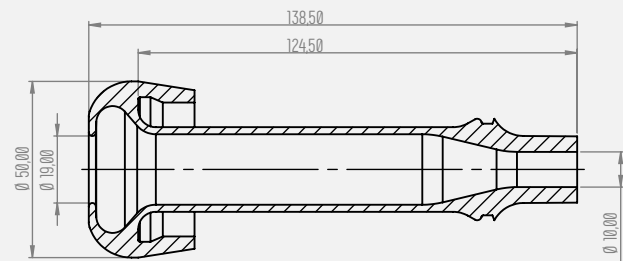
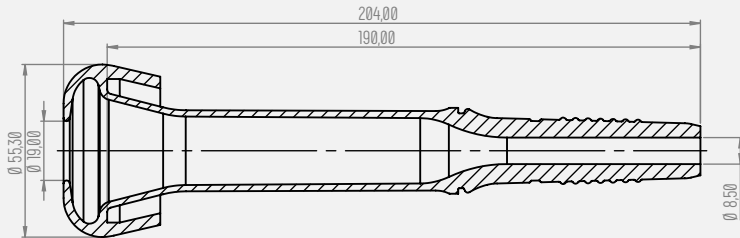

2

# Hortumlär / Hoses

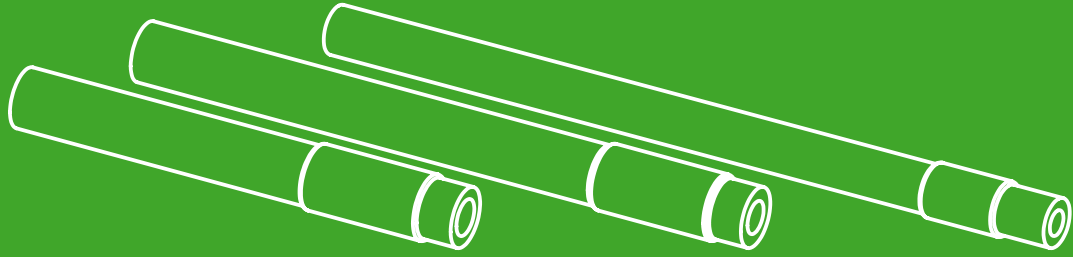
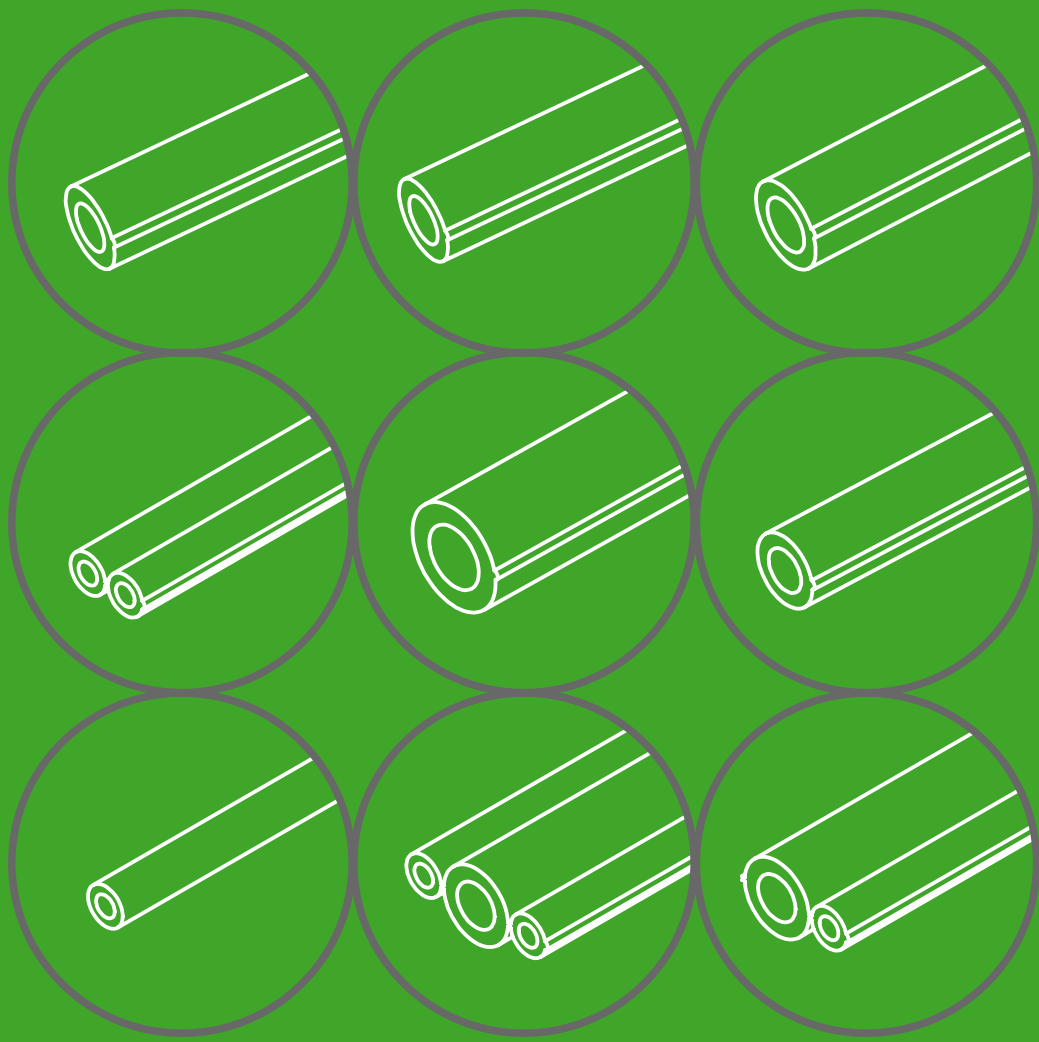



Mekanik hasarlara ve çalışma esnasında-  
ki olumsuzluklara karşı güçlü et kalınlığı.  
Uzun Ömürlü Kullanım.  
Sağlam ve Standart imalat yöntemi.  
GIDA için tam uyumlu.  
Made of material that is resistant to  
impact and mechanical damage.  
Long term usage.  
Standard manufacturing method  
Food grade.

Maruz bırakılmayacak ortamlar;  
Environment not to be exposed. ;



**Güneş Işığı**  
**Direct Sunlight**



**Kesici Meteryaller**  
**Sharp Objects**



**Darbe**  
**Beware of Bumps**



**Yağ**  
**Oil**



**Aşırı Sıcak**  
**Hyper Heat**

**Oncel**<sup>®</sup>

**Aklınızda ne varsa....**  
**What is in your mind...**

[www.oncelmak.com](http://www.oncelmak.com)



#oncelmakina

**ÖC.009** Uzun Süt Hortumu - Long Milk Hose  
Tip / Type : Kauçuk / Rubber



**ÖC.009/A** Uzun Süt Hortumu - Long Milk Hose  
Tip / Type : Şeffaf / Transparante

**ÖC.009/B** Uzun Süt Hortumu - Long Milk Hose  
Tip / Type : Renkli Silikon / Color Silicone  
●●● Opsiyonel İsteğe bağlı farklı renkte Üretilebilir.  
Color may vary due to order.

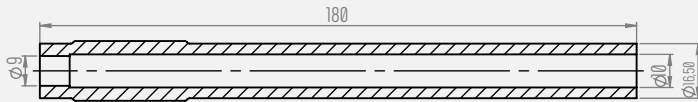

**ÖC.010** Kısa Süt Hortumu - Short Milk Hose  
Tip / Type : Kauçuk / Rubber



**ÖC.010/A** Kısa Süt Hortumu - Short Milk Hose  
Tip / Type : Şeffaf / Transparante

**ÖC.010/B** Kısa Süt Hortumu - Short Milk Hose  
Tip / Type : Renkli Silikon / Color Silicone  
●●● Opsiyonel İsteğe bağlı farklı renkte Üretilebilir.  
Color may vary due to order.

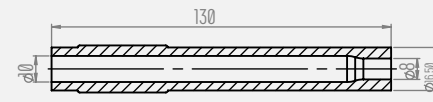

**ÖC.011** Hava Hortumu - Air Hose  
Tip / Type : Kauçuk / Rubber



**ÖC.011/A** Hava Hortumu - Air Hose  
Tip / Type : Şeffaf / Transparante

**ÖC.011/B** Hava Hortumu - Air Hose  
Tip / Type : Renkli Silikon / Color Silicone  
●●● Opsiyonel İsteğe bağlı farklı renkte Üretilebilir.  
Color may vary due to order.

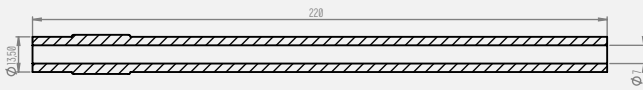

**ÖC.056** S Tipi Plastik Hortum Tutucu  
S Type Plastic Hose Clip



●● Opsiyonel İsteğe bağlı farklı renkte Üretilebilir.  
●● Color may vary due to order.

**ÖC.056-1** Y Tipi Plastik Hortum Tutucu  
Y Type Plastic Hose Clip



●● Opsiyonel İsteğe bağlı farklı renkte Üretilebilir.  
●● Color may vary due to order.

**ÖC.174** Hortum Tipi Süt Filtresi  
Tube Type Milk Filter



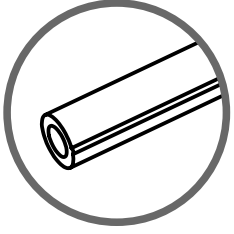

## Tekli Süt Hortumu Single Milk Hose



Kod / Code	A	B	Ölçü / Dimension	Renk / Color	Çizgi / Line
ÖC.Ø12	Ø22	Ø14	50 mt.	Şeffaf / Transparent	Kırmızı / Red
ÖC.Ø12-5	Ø22	Ø14	2.25mt.	Şeffaf / Transparent	Kırmızı / Red
ÖC.Ø12-A	Ø22	Ø14	50 mt.	Siyah / Black	Kırmızı / Red
ÖC.Ø12-B	Ø22	Ø14	50 mt.	Mavi / Blue	Kırmızı / Red
ÖC.Ø12-1	Ø16	Ø11	50 mt.	Şeffaf / Transparent	Kırmızı / Red
ÖC.Ø12-1/A	Ø16	Ø11	50 mt.	Siyah / Black	Kırmızı / Red
ÖC.Ø12-1/B	Ø16	Ø11	50 mt.	Mavi / Blue	Kırmızı / Red
ÖC.Ø12-2	Ø23	Ø16	50 mt.	Şeffaf / Transparent	Kırmızı / Red
ÖC.Ø12-2/A	Ø23	Ø16	50 mt.	Siyah / Black	Kırmızı / Red
ÖC.Ø12-2/B	Ø23	Ø16	50 mt.	Mavi / Blue	Kırmızı / Red
ÖC.Ø12-3	Ø32	Ø19	50 mt.	Şeffaf / Transparent	Kırmızı / Red
ÖC.Ø12-3/A	Ø32	Ø19	50 mt.	Siyah / Black	Kırmızı / Red
ÖC.Ø12-3/B	Ø32	Ø19	50 mt.	Mavi / Blue	Kırmızı / Red
ÖC.Ø12-4	Ø21	Ø13	50 mt.	Şeffaf / Transparent	Kırmızı / Red
ÖC.Ø12-4/A	Ø21	Ø13	50 mt.	Siyah / Black	Kırmızı / Red
ÖC.Ø12-4/B	Ø21	Ø13	50 mt.	Mavi / Blue	Kırmızı / Red

Kod / Code	A	B	Ölçü / Dimension	Renk / Color	Çizgi / Line
ÖC.Ø12-6	Ø24	Ø14	50 mt.	Şeffaf / Transparente	Kırmızı / Red
ÖC.Ø12-6/A	Ø24	Ø14	50 mt.	Siyah / Black	Kırmızı / Red
ÖC.Ø12-6/B	Ø24	Ø14	50 mt.	Mavi / Blue	Kırmızı / Red
ÖC.Ø12-7	Ø26	Ø16	50 mt.	Şeffaf / Transparente	Kırmızı / Red
ÖC.Ø12-7/A	Ø26	Ø16	50 mt.	Siyah / Black	Kırmızı / Red
ÖC.Ø12-7/B	Ø26	Ø16	51 mt.	Mavi / Blue	Kırmızı / Red

●●● Opsiyonel isteğe bağlı farklı renkte Üretilebilir. Color may vary due to order.

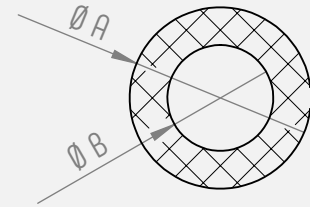

## Tekli Nabız Hortumu - Single Pulse Hose

Kod / Code	A	B	Ölçü / Dimension	Renk / Color	Çizgi / Line
ÖC.013-1	Ø13	Ø7	50 mt.	Şeffaf / Transparente	Kırmızı / Red
ÖC.013-1/A	Ø13	Ø7	50 mt.	Siyah / Black	Kırmızı / Red
ÖC.013-1/B	Ø13	Ø7	50 mt.	Mavi / Blue	Kırmızı / Red

- Opsiyonel İsteğe bağlı farklı renkte Üretilebilir.
- Color may vary due to order.

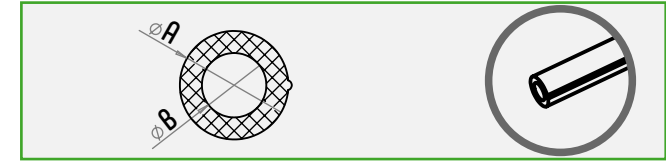

## İkili Nabız Hortumu - Twin Pulse Hose

Kod / Code	A	B	Ölçü / Dimension	Renk / Color	Çizgi / Line
ÖC.013	Ø13	Ø7	50 mt.	Şeffaf / Transparente	Kırmızı / Red
ÖC.013-A	Ø13	Ø7	50 mt.	Siyah / Black	Kırmızı / Red
ÖC.013-A/1	Ø13	Ø7	2.25 mt.	Siyah / Black	Kırmızı / Red
ÖC.013-B	Ø13	Ø7	50 mt.	Mavi / Blue	Kırmızı / Red
ÖC.013-2	Ø13	Ø7	2.25 mt.	Şeffaf / Transparente	Kırmızı / Red

- Opsiyonel İsteğe bağlı farklı renkte Üretilebilir.
- Color may vary due to order.

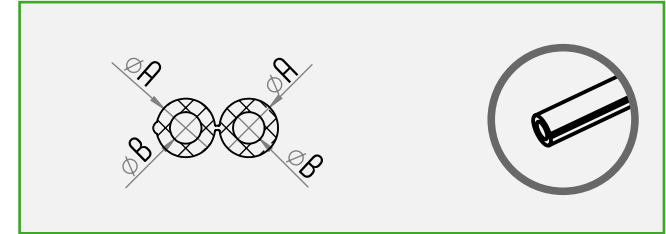

## Üçlü Süt Hortumu - Triple Milk Hose

Kod / Code	A	B	Ölçü / Dimension	Renk / Color	Çizgi / Line
ÖC.014	Ø24-Ø13	Ø14-Ø7	50 mt.	Şeffaf / Transparente	Kırmızı / Red
ÖC.014-A	Ø24-Ø13	Ø14-Ø7	50 mt.	Siyah / Black	Kırmızı / Red
ÖC.014-B	Ø24-Ø13	Ø14-Ø7	50 mt.	Mavi / Blue	Kırmızı / Red
ÖC.014-1	Ø24-Ø13	Ø14-Ø7	2.25 mt.	Şeffaf / Transparente	Kırmızı / Red

- Opsiyonel İsteğe bağlı farklı renkte Üretilebilir.
- Color may vary due to order.

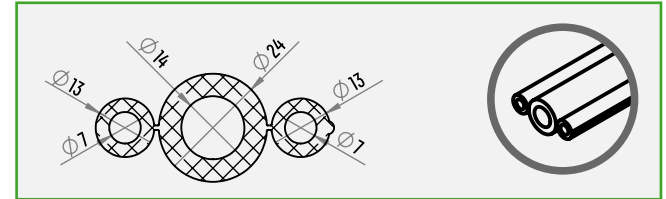

ÖC.068 Uzun Tip Hortum Fırçası - Long Type Tube Brush

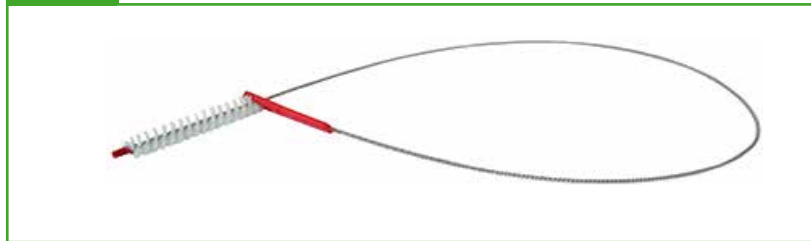

ÖC.071 Parmak Tipi Hortum Fırçası - Finger Type Tube Brush

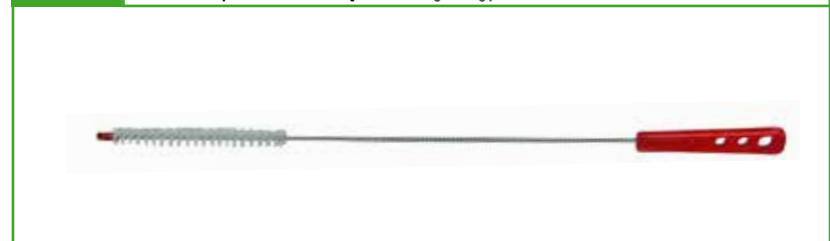

ÖC.069-1 Kısa Tip Hortum Fırçası - Short Type Tube Brush



ÖC.069 Kısa Tip Hortum Fırçası - Short Type Tube Brush



3

# Sağım Başığı ve Aksesuarları

## Milking Clusters and Accessories

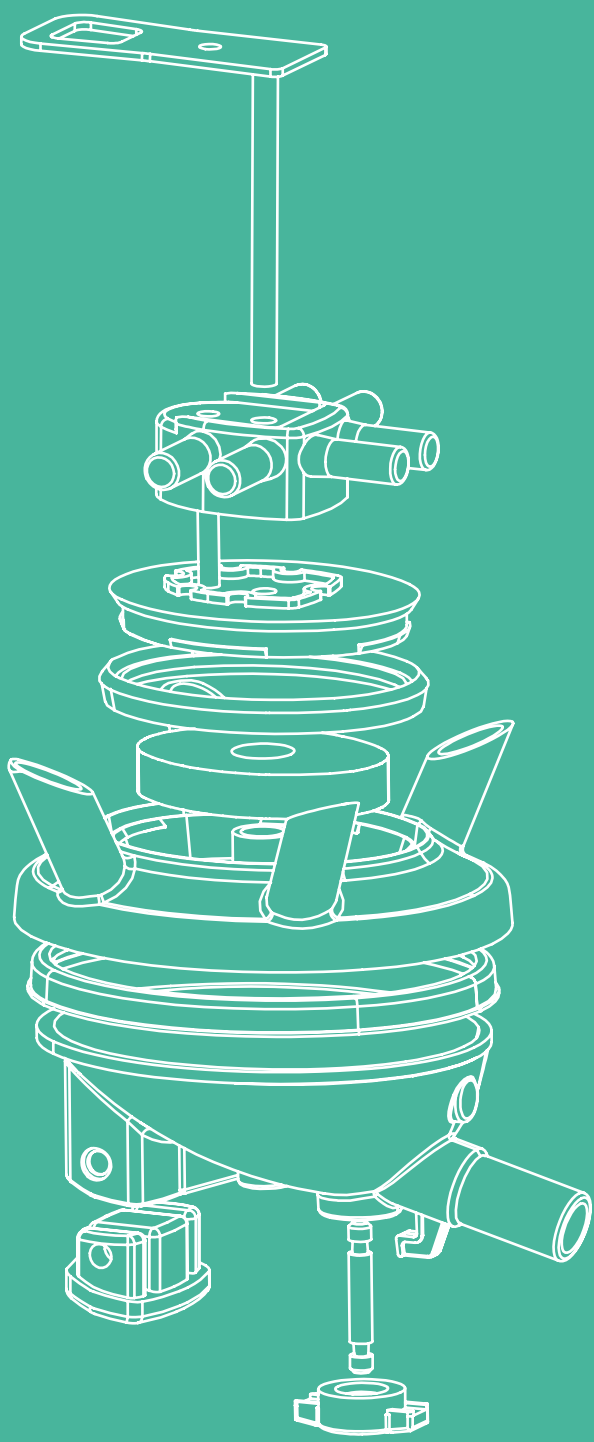



Sađım bařlıđı ve Aksesuarları; Tümüyle "gıdaya uygun" ve kullanımı kolay ve dayanıklıdır. Çiftliklerde kullanılıp, sürekli iyileřtirme çalışmaları yaparak, saha tecrübesi ve mevcut tüm sađım bařlıklarının izleyip, eksikliklerinin belirlenmesi neticesinde yüksek verimlilik için yetersizliklerini ortadan kaldıran bir yapıya sahiptir. Sütü, ineđin dođasına uygun, Hijyen çerçevesinde üretilen malzemeler bütünüdür.

Oncel milk clusters are designed with beneficial characteristics that will help increase milking efficiency and improve animal health. Can be used in the farms and always improved through the field research studies and monitorings.



Tecrübenin sađlamlıđı...  
The strength of experience...

[www.oncelmak.com](http://www.oncelmak.com)





ÖC.124 240cc Sağım Başlığı (Komple) - 240cc Milking Cluster (Complete)

ÖC.124-1 340cc Sağım Başlığı (Komple) - 340cc Milking Cluster (Complete)



Gr.  
2000gr.

1 -ÖC.154 240cc Süt Pençesi Komple - 240 cc Milking Claw Complete

2 -ÖC.011 Hava Hortumu - Air Hose

3 -ÖC.027-1/A Kadehli Tip Kılıf - Glass Type Teat Cup Shell

4 -ÖC.006-1 Uzun Tip Süt Lastiği - Long Type Milking Liner

ÖC.125 150cc Sağım Başlığı (Komple) - 150cc Milking Cluster (Complete)

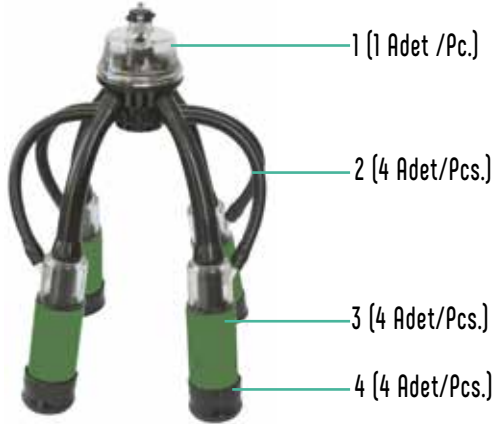

Gr.  
2040gr.

1 -ÖC.091 150cc Süt Pençesi Komple - 150 cc Milking Claw Complete

2 -ÖC.011 Hava Hortumu - Air Hose

3 -ÖC.026 Şeffaf Kılıf (Komple) - Transparent Teat Cup Shell (Complete)

4 -ÖC.006-1 Uzun Tip Süt Lastiği - Long Type Milking Liner

ÖC.124-A 240cc Sağım Başlığı (Komple) - 240cc Milking Cluster (Complete)

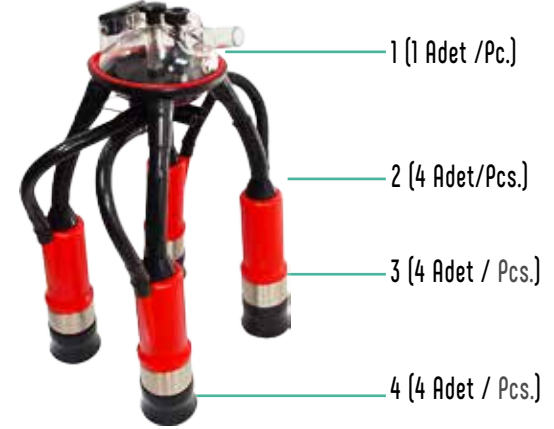

Gr.  
2000gr.

1 -ÖC.154 240cc Süt Pençesi Komple - 240 cc Milking Claw Complete

2 -ÖC.011 Hava Hortumu - Air Hose

3 -ÖC.026-1 Plastik Kılıf - Plastic Teat Cup Shell

4 -ÖC.006-1 Uzun Tip Süt Lastiği - Long Type Milking Liner

ÖC.125-1 160cc Süt Gözlemeli Sağım Başlığı - 160cc Milking Cluster Shell With Indicator

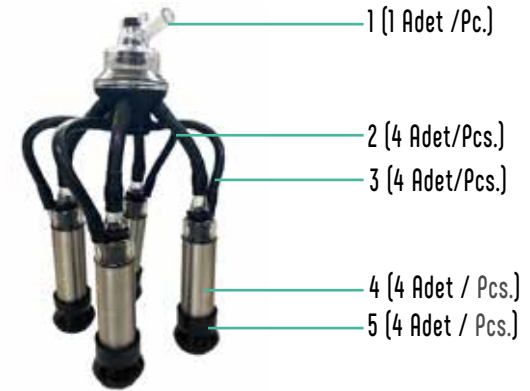

Gr.  
1960 gr.

1 -ÖC.091-1 160cc Süt Pençesi Komple - 160 cc Milking Claw Complete

2 -ÖC.010 Kısa Süt Hortumu - Short Milk Hose

3 -ÖC.011 Hava Hortumu - Air Hose

4 -ÖC.027-1/A Paslanmaz Kılıf - Stainless Steel Teat Cup Shell

5 -ÖC.002 Kısa Tip Süt Lastiği - Short Type Milking Liner

## ÖC.125-2 200cc Sağım Başlığı - 200cc Milking Cluster



Gr.  
1960 gr.

1 -ÖC.142 200cc Süt Peçesi Komple - 200 cc Milking Claw Complete

2 -ÖC.011 Hava Hortumu - Air Hose

3 -ÖC.027-1/A Kadehli Tip Kılıf - Glass Type Teat Cup Shell

4 -ÖC.006-1 Uzun Tip Süt Lastiği - Long Type Milking Liner

## ÖC.125-4 160cc Sağım Başlığı (Silikon) - 160cc Milking Cluster (Silicone)

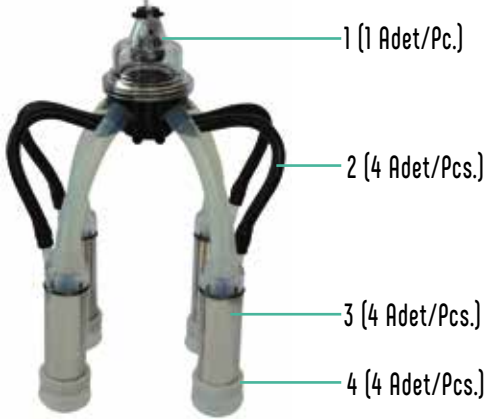

Gr.  
1960 gr.

1 -ÖC.091-1 160cc Süt Peçesi Komple - 160 cc Milking Claw Complete

2 -ÖC.011 Hava Hortumu - Air Hose

3 -ÖC.027-1/A Kadehli Tip Kılıf - Glass Type Teat Cup Shell

4 -ÖC.004-1 Uzun Tip Silikon Süt Lastiği - Long Type Silicone Milking Liner

## ÖC.125-3 200cc Sağım Başlığı - 240cc Milking Cluster



Gr.  
1880 gr.

1 -ÖC.142 200cc Süt Peçesi Komple - 200 cc Milking Claw Complete

2 -ÖC.011 Hava Hortumu - Air Hose

3 -ÖC.026-1 Plastik Kılıf (Komple) - Plastic Type Teat Cup Shell (Complete)

4 -ÖC.006-1 Uzun Tip Süt Lastiği - Long Type Milking Liner

## ÖC.125-5 240cc Sağım Başlığı (Komple) Renkli Silikon - 240cc Milking Cluster Colored Silicone



Gr.  
2100 gr.

1 -ÖC.154 240cc Süt Peçesi Komple - 240 cc Milking Claw Complete

2 -ÖC.011 Hava Hortumu - Air Hose

3 -ÖC.027 Paslanmaz Kılıf - Stainless Steel Teat Cup Shell

4 -ÖC.004-1/A Uzun Tip Süt Lastiği - Long Type Milking Liner

ÖC.124/B 160 cc Sağım Başlığı (Komple) Eko - 160 cc Milking Cluster (Complete) Eko



1 (1 Adet/Pc.)

2 (4 Adet/Pcs.)

3 (4 Adet/Pcs.)

4 (4 Adet/Pcs.)

Gr.  
2100 gr.

1 -ÖC.091-1 160cc Süt Pençesi Komple - 160 cc Milking Claw Complete

2 -ÖC.011 Hava Hortumu - Air Hose

3 -ÖC.026-1/A Plastik Kılıf (Komple) - Plastic Type Teat Cup Shell (Complete)

4 -ÖC.004 Uzun Tip Süt Lastiği - Long Type Milking Liner

ÖC.154-1 340cc Süt Pençesi (Komple) - 340cc Milk Claw (Complete)



Gr.  
580 gr.

ÖC.154-1/A



Gr.  
600 gr.

Pençe Çıkarcılı Uyumlu - Available Cluster Remover

ÖC.155-4 340cc Süt Pençesi Üst Kapak (Komple)  
340cc Milk Claw Upper Lid (Complete)



ÖC.155-7 340cc Süt Pençesi Üst Kapak  
340cc Milk Claw Upper Lid



ÖC.126 Kılıflı Süt Lastiği (Komple) - Teat Cup Shell Milking Liner (Komple)

ÖC.126-1 Gösterge Kılıflı Kısa Süt Lastiği (Komple) - Shell With Indicator (Complete)



1

1

2

3

4

5

1 -ÖC.010 Kısa Süt Hortumu - Short Milk Hose

2 -ÖC.011 Hava Hortumu - Air Hose

3 -ÖC.031 Süt Akış Göstergeleri - Milk Flow Sight Glass

4 -ÖC.027-1/A Paslanmaz Kılıf - Stainless Steel Teat Cup Shell

5 -ÖC.002 Kısa Tip Süt Lastiği - Short Type Milking Liner

6 -ÖC.004 Uzun Tip Süt Lastiği - Long Type Milking Liner

ÖC.154 240cc Süt Pençesi (Komple) - 240cc Milk Claw (Complete)



Gr.  
540 gr.

ÖC.154-A



Gr.  
580 gr.

Pençe Çıkarcılı Uyumlu - Available Cluster Remover

ÖC.155 240cc Süt Pençesi Üst Kapak (Komple)  
240cc Milk Claw Upper Lid (Complete)



ÖC.155-6 240cc Süt Pençesi Üst Kapak  
240cc Milk Claw Upper Lid



340cc & 240 cc Teknik Patlatma / Technical Explode

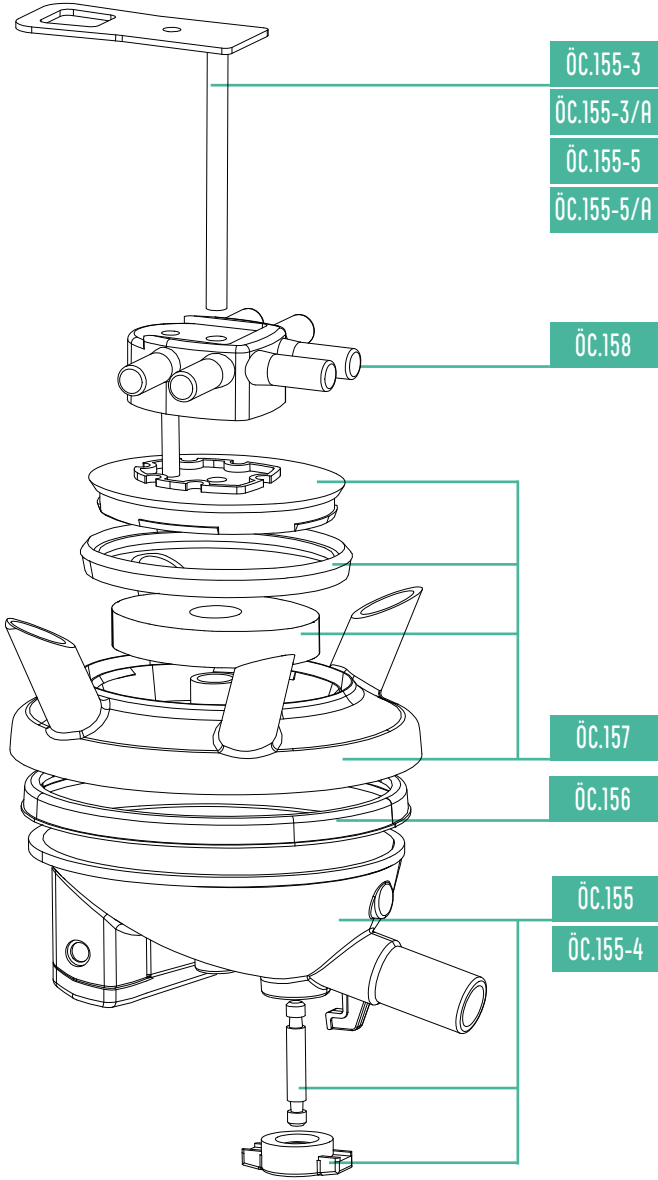

ÖC.156 340cc & 240 cc Süt Peçe Contası  
340cc & 240cc Milk Claw Gasket



ÖC.157 340cc & 240cc Süt Peçe Gövdesi  
340cc & 240cc Milk Claw Body



ÖC.158 340cc & 240 cc Süt Peçe Hava Dağıtıcı  
340cc & 240cc Milk Claw Air Spreader



ÖC.155-1 340cc & 240cc Süt Peçe Somunu  
340cc & 240cc Milk Claw Nut



ÖC.155-2 340cc & 240cc Süt Peçe O-ringi  
340cc & 240cc Milk Claw O-ring



ÖC.155-3 240 cc Süt Peçe Askısı  
240cc Milk Claw Suspender



ÖC.155-5 340cc Süt Peçe Askısı  
340cc Milk Claw Suspender



ÖC.155-3/A 240 cc Süt Peçe Askısı  
240cc Milk Claw Suspender



ÖC.155-5/A 340cc Süt Peçe Askısı (Çıkarıcı Tip)  
340cc Milk Claw Suspender (Remover type)



ÖC.091 150cc Süt Pençesi (Komple)  
150cc Milking Claw (Complete)



Gr.  
400 gr.

Tamamen Gıdaya uygun, kanserojen madde içermeyen hammadde'den üretilmektedir. Üst Kapak, sütün gözlenebilmesi için Polikarbon Şeffaf malzemeden üretilmektedir. Tasarımında Sütün temas ettiği iç yapısında kesin köşelerden kaçınılmıştır. Vakum kapatıcı olarak bilinen pençe küresi kauçuk malzemeden üretilip, Kaçağın önlenmesi için Yoğunluğu düşük malzemeden yapılmaktadır. İç Hacim : 150cc Süt hortum çapı : Ø18 mm

ÖC.091-1 160cc Süt Pençesi (Komple)  
160cc Milking Claw (Complete)



Gr.  
460 gr.

Tamamen Gıdaya uygun, kanserojen madde içermeyen hammadde'den üretilmektedir. Üst Kapak, sütün gözlenebilmesi için Polikarbon Şeffaf malzemeden üretilmektedir. Tasarımında Sütün temas ettiği iç yapısında kesin köşelerden kaçınılmıştır. Vakum kapatıcı olarak bilinen pençe küresi kauçuk malzemeden üretilip, Kaçağın önlenmesi için Yoğunluğu düşük malzemeden yapılmaktadır. Alt Gövde Ağırlıkla birlikte basılmaktadır ve bu sayede bütün olarak mamül halinde üretilmektedir.

ÖC.089 150cc Süt Pençe Kapak Komple  
150cc Milk Claw Cover Complete



Made of completely food-grade, non-carcinogenic raw material. The Top Cover is made of Transparent Polycarbonate to observe the milk flow . It is designed without any corners inside of the structure where it is comes in contact with milk. Known as a vacuum sealer of the claw is made of rubber and low density material to prevent milk leaking. Internal Volume : 150cc Milk hose diameter : Ø18 mm

ÖC.090 160cc Süt Pençe Kapak Komple  
160cc Milk Claw Cover Complete



İç Hacim : 160cc  
Süt hortum çapı : Ø18 mm

Made of completely food-grade, non-carcinogenic raw material. The Top Cover is made of Transparent Polycarbonate to observe the milk flow . It is designed without any corners inside of the structure where it is comes in contact with milk. Known as a vacuum sealer of the claw is made of rubber and low density material to prevent milk leaking. Lower Body of a claw is developed together with weight and it is produced as a whole part.

ÖC.087 150cc Süt Pençe Gövdesi  
150cc Milk Claw Body



ÖC.088 150cc Süt Pençesi Şeffaf Kapak  
150cc M. Claw Transparent Cover



ÖC.088-1 160cc Süt Pençesi Şeffaf Kapak  
160cc M. Claw Transparent Cover



Internal Volume: 160cc  
Milk hose diameter: Ø18 mm

ÖC.093 160cc Süt Pençe Hava Dağıtıcı  
160cc Milk Claw Air Spreader



ÖC.092-1 150cc Süt Pençe Contası  
150cc Milk Claw Gasket



ÖC.087-1 160cc Süt Pençe Gövdesi  
160cc Milk Claw Body



ÖC.092 160cc Süt Pençe Contası  
160cc Milk Claw Gasket



ÖC.142 200cc Süt Peçesi Komple  
200cc Milk Claw Complete



ÖC.094 200cc Süt Peçe Gövdesi  
200cc Milk Claw Body



ÖC.098 200cc Süt Peçesi Kapak Korumucu  
200cc M. Claw Cover Protector



ÖC.095 200cc Süt Peçesi Hava Dağıtıcı  
200cc Milk Claw Air Spreader



ÖC.097 200cc Süt Peçe Şeffaf Kapak  
200cc Milk Claw Transparent Cover



ÖC.097-1 200cc Süt Peçesi Şeffaf Kapak  
200cc M. Claw Transparent Cover



ÖC.097-2 200cc Süt Peçe Contası  
200cc Milk Claw Gasket



ÖC.096 200cc Süt Peçesi Gövde Ağırlığı  
200cc Milk Claw Body Weight



### Süt Peçesi Kelebekleri - Milk Claw Air Stopper Nuts

Resimler 2:1 Oranında Büyütülmüştür. - The pictures were Scala at 2: 1 ratio.



ÖC.100-1



ÖC.100-4



ÖC.100-5



ÖC.100-6

ÖC.101 Süt Peçe Küresi  
150cc Milk Claw Air Stopper



\*VM.014  
Süt Peçe Küre  
Mili inox

ÖC.131 Süt Peçe Küresi  
200 cc Milk Claw Air Stopper



### Süt Peçesi Küreleri - Milk Claw Air Stoppers



ÖC.102

Vidalı Tip  
Screw Type



ÖC.104

Mantar Tip  
Mushroom Type



ÖC.106

ÖC.103 Süt Peçe Küresi  
160 cc Milk Claw Air Stopper



ÖC.105 Süt Peçe Küresi  
240cc & 340cc Milk Claw Air Stopper



\*VM.069  
Süt Peçe Küre  
Mili Plastik

**ÖC.026** Şeffaf Kılıf Komple (Boyalı Tip)  
Transparent Teat Cup Shell Complete (Colored)

Opsiyonel İsteğe bağlı farklı renkte Üretilebilir. Color may vary due to order



**ÖC.026-2** Şeffaf Kılıf Komple (Kadmiyum)  
Transparent Teat Cup Shell Complete (Cadmium)

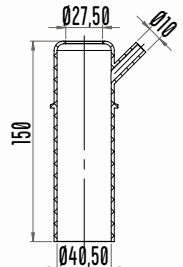

**ÖC.024** PC.Şeffaf Kılıf - PC. Transparent Teat Cup Shell

**ÖC.025** Şeffaf Kılıf Ağırlığı (Boyalı Tip)  
Transparent Teat Cup Shell Weight (Colored)

Opsiyonel İsteğe bağlı farklı renkte Üretilebilir. Color may vary due to order



**ÖC.025-2** Şeffaf Kılıf Komple (Boyalı Tip)  
Transparent Teat Cup Shell Complete (Colored)

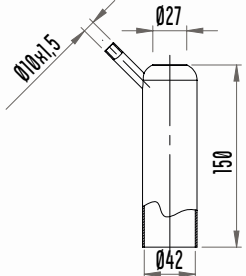

**ÖC.027** Paslanmaz Kılıf - Stainless Steel Teat Cup Shell

**ÖC.026-1** Plastik Kılıf Komple Plastic Teat Cup Shell Complete (A-Ø27mm)

**ÖC.026-5** Plastik Kılıf Komple Polikarbon Plastic Teat Cup Shell Complete PC. (A-Ø27mm)

**ÖC.026-4** Plastik Kılıf Komple Plastic Teat Cup Shell Complete (A-Ø16mm)

**ÖC.026-3** Plastik Kılıf Komple Plastic Teat Cup Shell Complete (A-Ø18mm)



**ÖC.025-1** Paslanmaz Plastik Kılıf Ağırlığı  
S/S Transparent Teat Cup Shell Weight



48 Gr.

Opsiyonel İsteğe bağlı farklı renkte Üretilebilir. Color may vary due to order

**ÖC.024-1** Plastik Kılıf - Plastic Teat Cup Shell

**ÖC.024-2** Plastik Kılıf Polikarbon - Plastic Teat Cup Shell (PC)



**ÖC.027-1** Ø22 Kadehli Tip Kılıf  
Ø22 Glass Type Teat Cup Shell



**ÖC.027-1/A** Ø27 Kadehli Tip Kılıf  
Ø27 Glass Type Teat Cup Shell



## Kadeh - Teat Cup

ÖC.029 (A) Ø27 (2-Oring)

ÖC.029-1 (A) Ø22 (2-Oring)

ÖC.029-2 (A) Ø16 (2-Oring)

ÖC.029-5 (A) Ø17 (2-Oring)

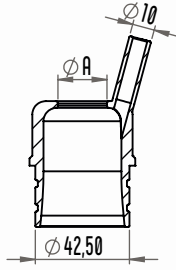

ÖC.028

Kadeh O-ringi (Ø29x2,5)  
Teat Cup O-ring (Ø29x2,5)

ÖC.052-1

Körtapa - Plug



## ÖC.133 Keçi Süt Lastiği Kılıfı - Goat Milking Liner Cup

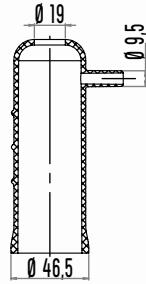

## ÖC.133-1 Koyun Süt Lastiği Kılıfı - Sheep Milking Liner Cup

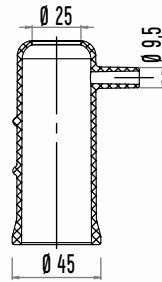
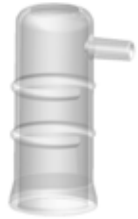

## Süt Akış Göstergeleri - Milk Flow Sight Glass

ÖC.032-1

ÖC.031-1

ÖC.031





Keçi Sağım Başlığı (Komple) - Goat Milking Cluster (Komple)

ÖC.132 Silikon Süt Lastikli- Silicone Milk Liner

ÖC.132/A Kauçuk Süt Lastikli - Rubber Milk Liner



ÖC.134-A 100cc Küçükbaş Sağım Pençesi(Komple) - 100cc Sheep/Goat Milking Claw (Complete)



ÖC.134-B Küçükbaş Pençe Altı - Sheep/Goat Milk Claw Lower Piece

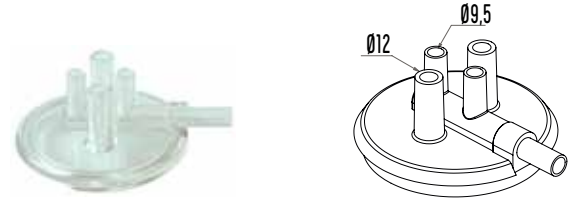

Koyun Sağım Başlığı (Komple) - Sheep Milking Cluster (Komple)

ÖC.169 Silikon Süt Lastikli- Silicone Milk Liner

ÖC.169/A Kauçuk Süt Lastikli - Rubber Milk Liner



ÖC.134-C Küçükbaş Pençe Kapağı (Komple) -Sheep/Goat Milk Claw Cover (Complete)



ÖC.134-D Paslanmaz Boru - Stainless Steel Tube

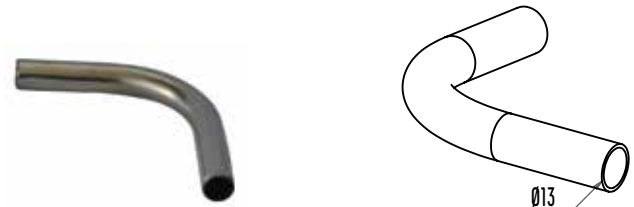

Keçi Sađım Bařlıđı (Komple) - Goat Milking Cluster (Komple)

ÖC.132-1 Silikon Süt Lastikli- Silicone Milk Liner

ÖC.132-1/A Kauçuk Süt Lastikli - Rubber Milk Liner



Koyun Sađım Bařlıđı (Komple) - Sheep Milking Cluster (Komple)

ÖC.169-1 Silikon Süt Lastikli- Silicone Milk Liner

ÖC.169-1/A Kauçuk Süt Lastikli - Rubber Milk Liner

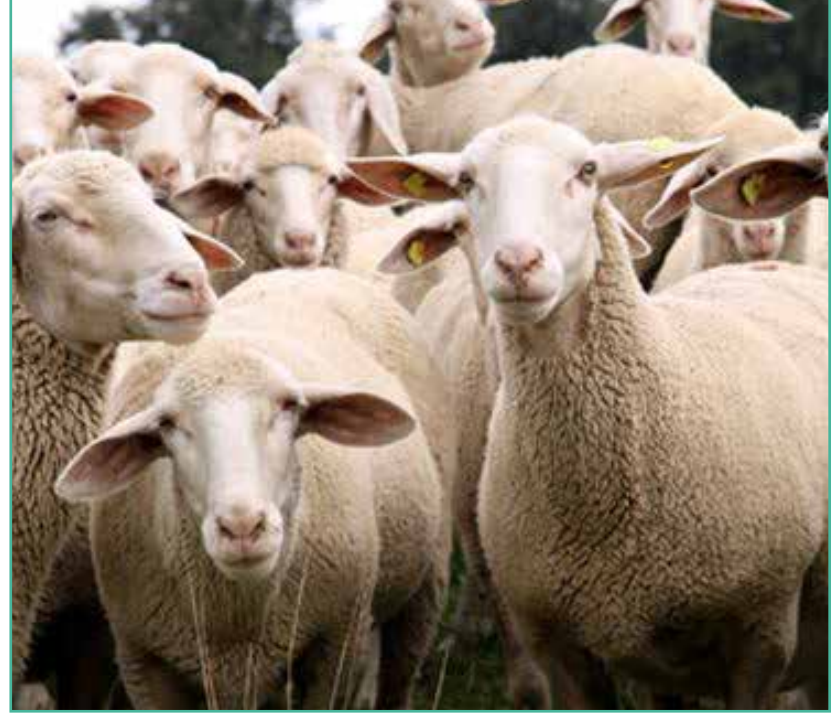

**Koyun Sağım Başlığı (Komple) - Sheep Milking Cluster (Komple)**

ÖC.169-2 Silikon Süt Lastikli- Silicone Milk Liner

ÖC.169-2/A Kauçuk Süt Lastikli - Rubber Milk Liner



**Keçi Sağım Başlığı (Komple) - Goat Milking Cluster (Komple)**

ÖC.132-2 Silikon Süt Lastikli- Silicone Milk Liner

ÖC.132-2/A Kauçuk Süt Lastikli - Rubber Milk Liner



ÖC.129 Küçükbaş Sağım Başlığı  
Sheep/Goat Milking Claw



ÖC.129-1 Küçükbaş Sağım Başlığı Camı  
Sheep/Goat Milking Claw Cover



ÖC.129-2 Küçükbaş Sağım Başlığı Contası  
Sheep/Goat Milking Claw Gasket



ÖC.129-3 Küçükbaş Sağım Başlığı Pimi  
Sheep/Goat Milking Claw Pin



ÖC.129-4 Küçükbaş Sağım Başlığı Diyaframı  
Sheep/Goat Milking Claw Diaphragm



Silikon - Silicone

ÖC.129-5 Küçükbaş Sağım Başlığı Üst Kapak  
Sheep/Goat Milking Claw Upper Lid



ÖC.129-6 Küçükbaş Sağım Başlığı Alt Somun  
Sheep/Goat Milking Claw Lower Nut



ÖC.129-7 Küçükbaş Sağım Başlığı Üst Somun  
Sheep/Goat Milking Claw Upper Nut



ÖC.135 Küçükbaş Sağım Başlığı Süt Çatalı - Sheep Milking Cluster Milk Clevis



Polikarbon - Polycarbon

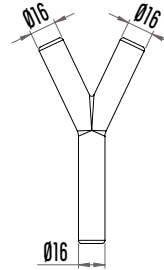

ÖC.136 Küçükbaş Sağım Başlığı Vakum Çatalı - Sheep Milking Cluster Vacuum Clevis

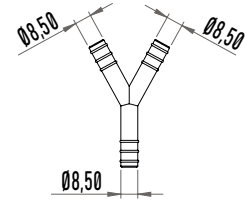

ÖC.137 Küçükbaş Sağım Başlığı Hortum Tutucu - Sheep Milking Cluster Hose Holder

Opsiyonel  
İsteğe bağlı  
farklı renkte  
Üretilebilir.  
Color may  
vary due to  
order

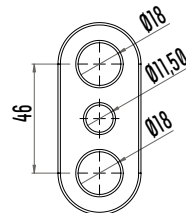

ÖC.137-1 Küçükbaş Sağım Başlığı Hortum Tutucu - Sheep Milking Cluster Hose Holder

Opsiyonel  
İsteğe bağlı  
farklı renkte  
Üretilebilir.  
Color may  
vary due to  
order

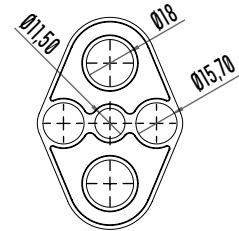

4

# Pulsatörler / Pulsators

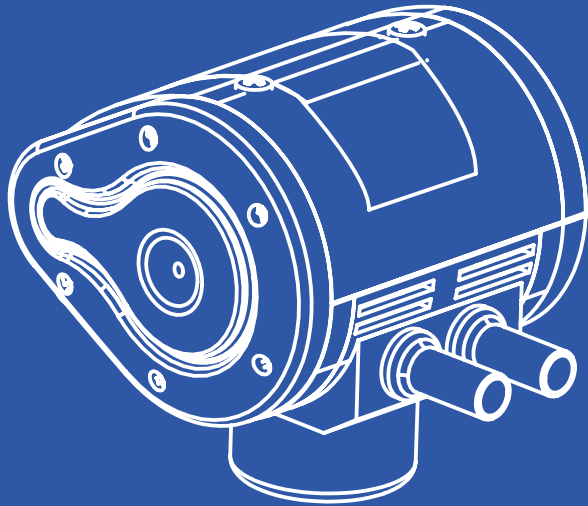

Pulse Diagram

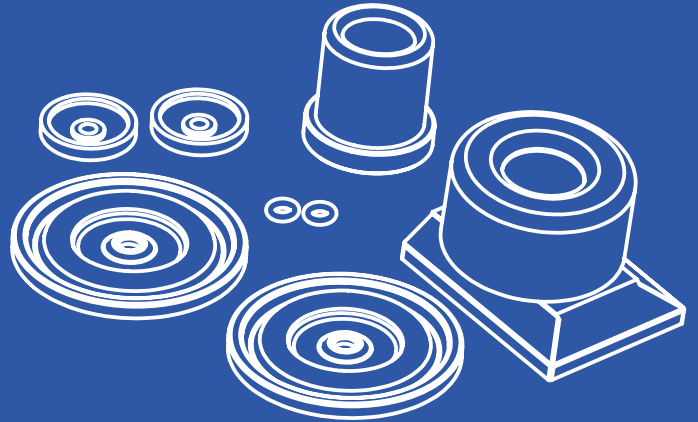
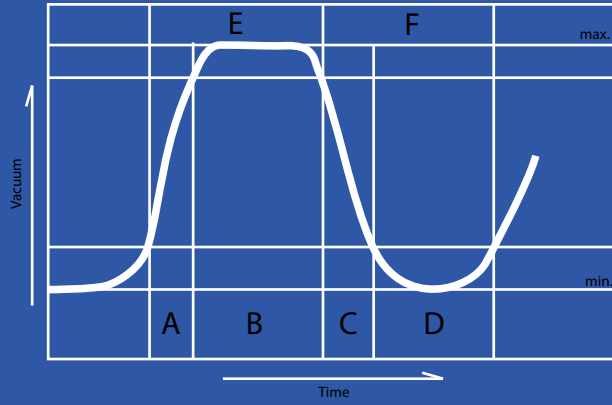



İnek, manda, koyun, keçi sağımalarında, seyyar veya sabit süt sağım sistemlerinde kullanılan, halk arasında 'BEYİN' olarak adlandırılan pulsatör, vakumun hayvanın sağlığına zarar vermeden, tüm sütün alınmasını ve sağımın uygun sürede, uygun nabız sayısı tolerans değerleri içerisinde devamlılığını sağlar.

Pulsator is used on the mobile milking machines and milking systems without affecting livestock and regulating the vacuum which runs inside the milking cluster and helps milking clusters to efficiently milk out.

	<b>Vakum (kPa) Vacuum (kpa)</b>	<b>Puls Pulse</b>	<b>Faz Phase</b>
<b>Manda / Buffalo</b>	<b>45</b>	<b>120</b>	<b>60/40</b>
<b>Koyun / Sheep</b>	<b>35-40</b>	<b>120</b>	<b>50/50</b>
<b>Keçi / Goat</b>	<b>38-42</b>	<b>90</b>	<b>70/30</b>
<b>inek / Cow</b>	<b>42-45</b>	<b>60</b>	<b>60/40</b>



**Gerçek Değerler...**  
**Real Values ...**

[www.oncelmak.com](http://www.oncelmak.com)

Pnömatik Pulsatör - Pneumatic Pulsator



ÖC.076

Pulsatör 1 (Üst Paslanmaz Kapaklı)  
Pulsator 1 (Stainless Steel Upper Lid)



ÖC.076-2

Pulsatör 3 (Üst Şeffaf Kapaklı)  
Pulsator 3 (Transparente Upper Lid)

Kullanım Alanı / Usage Area  
Seğim Oranı / Sort Rate  
Nabız Oranı / Pulse Rate  
Nabız Kontrolü / Pulse Control  
Hava Çıkışı / Air Output  
İç Plaka / Inner Plate  
Boyutları / Dimensions  
Ağırlık / Weight  
Yan Kapak Siyah, Mavi, Sarı, Kırmızı / Side lid Can be in Black, Blue, Yellow, Red Colors



:İnek-Cow  
:60/40



:Koyun-Sheep  
:70/30



:Keçi-Goat  
:50/50

:Ayarlanabilir - Adjustable  
:Diyaframlı Mekanizma - Diaphragm Mechanism  
:Çift Çıkış - Double Output  
:İnox ( Krom )- Inox (Chrome)  
:91\*108\*86  
:0.330 kg

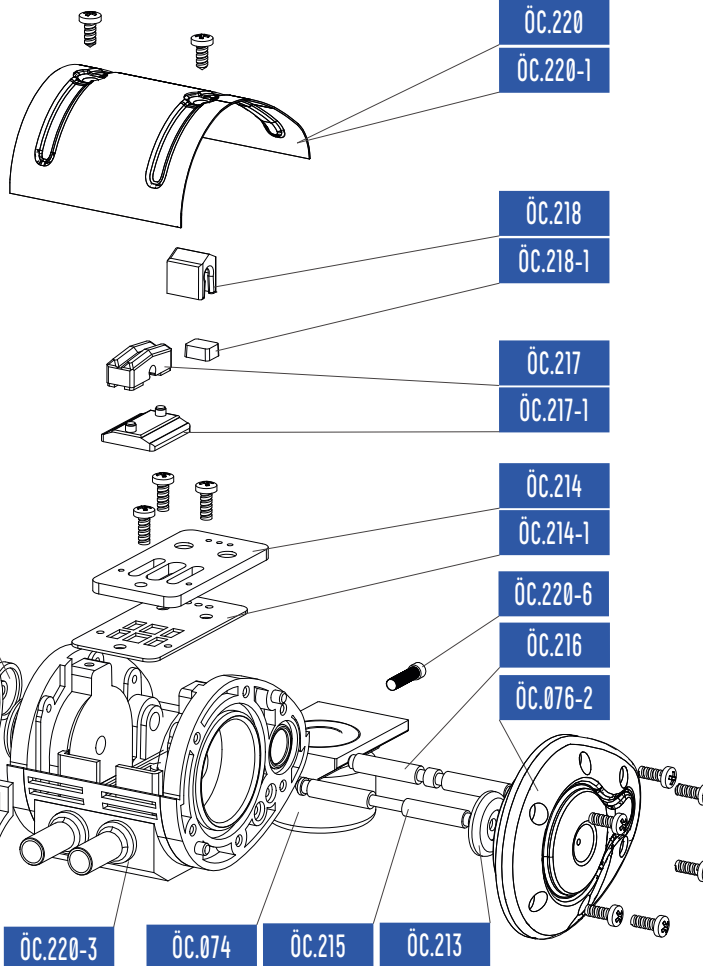

ÖC.220

ÖC.220-1

ÖC.218

ÖC.218-1

ÖC.217

ÖC.217-1

ÖC.214

ÖC.214-1

ÖC.220-6

ÖC.216

ÖC.076-2

ÖC.073

ÖC.072

ÖC.220-4

ÖC.220-2

ÖC.220-3

ÖC.074

ÖC.215

ÖC.213

Pulsatör Sağım, meme başlıklarına vakum kontrolü bir şekilde verilmesi sağlanmaktadır. Hayvanların kan dolaşım, nabız atışına göre vakumlama yaparak sistem çalışır.

Meme başlıklarına sürekli vakum verilmesi ile Vakumun aralıklarla kesilmesi bazı meme hastalıklarına sebep olmaktadır. Bunun yerine vakum belli aralıklarla kesilmesi ve kan dolaşımının sağlanması gerekmektedir. yüksek güvenilirlik ve maksimum dayanıklılık sağlamlığa özelliğine sahiptir.

Pulsator provides controlled vacuum to the milking clusters. The system works by vibrating according to blood circulation, pulse rate of the herd.

Continuous vacuum given to the clusters and used unsuitable Vacuum intervals can cause some breast diseases. Instead, vacuum should be cut at certain intervals providing appropriate blood circulation.

ÖC.220 Pulsatör Üst Kapak (Paslanmaz) Pulsator Top Lid (Stainless Steel)

Malzeme / Material :Inox - Inox



ÖC.220-1 Pulsatör Üst Kapak PC - Pulsator Top Lid Polycarbonate

Malzeme / Material :Polikarbon - Polycarbon



ÖC.220-3 Pulsatör Gövdesi - Pulsator Body

Malzeme / Material :Polyamid - Poliamide



ÖC.220-4 Pulsatör Sağ Yan Kapak - Pulsator Right Side Lid

ÖC.220-5 Pulsatör Sol Yan Kapak - Pulsator Left Side Lid

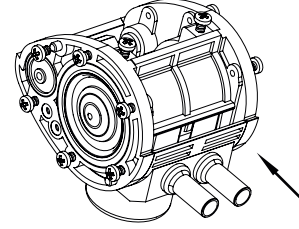

ÖC.077 Pulsatör Diyafram Takımı - Pulsator Diaphragm Set

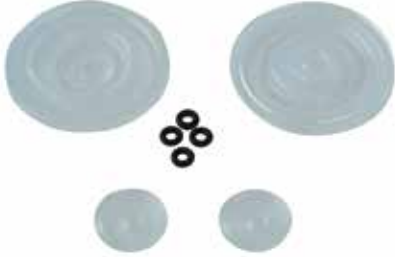
ÖC.072 Pulsatör Büyük Diyafram  
Pulsator Big Diaphragm

Silikon / Silicone

ÖC.073 Pulsatör Küçük Diyafram  
Pulsator Small Diaphragm

Silikon / Silicone

ÖC.215 Pulsatör Büyük Diyafram Mili  
Pulsator Big Diaphragm ShaftÖC.216 Pulsatör Küçük Diyafram Mili  
Pulsator Small Diaphragm Shaft

Malzeme / Material :Inox - Inox



Malzeme / Material :Inox - Inox

ÖC.220-2 Pulsatör Kapak Filtre  
Pulsator Lid FilterÖC.220-6 Pulsatör Hız Ayar Vidası  
Pulsator Speed Adjusting Screw





## Elektronik Pnömatik Pulsatörler - Electronic Pneumatic Pulsator



60/40 ÖC.192

60/40 ÖC.192-1



Elektronik Kartlı-Büyükbaş Pulsatör  
Electronic With Card-Cattle Pulsator

Elektronik Kartsız-Büyükbaş Pulsatör  
Electronic Without Card-Cattle Pulsator

50/50 ÖC.208 70/30

50/50 ÖC.208-1 70/30



Elektronik Kartlı-Küçükbaş Pulsatör  
Electronic With Card-For Goat & Sheep

Elektronik Kartsız-Küçükbaş Pulsatör  
Electronic Without Card-For Goat & Shee

ÖNCEL Elektronik Pulsatörleri hava ısı faktörü ve vakum seviyelerindeki dalgalanma farklarından etkilenmez. Her sağım ünitesi için bir pulsatör kullanılır. Pulsatörler merkezi elektronik kontrol ünitesine bağlı olarak çalışır. Bu kontrol kutusu nabız sayısını, ve nabız oranını ayarlar, ayrıca sistem içi vakum dalgalanmasını engellemek için pulsatörlerin ardışık çalışmasını kontrol eder.

ÖNCEL Electronic Pulsators are not affected by fluctuation differences in air heat factor and vacuum levels. A pulsator is used for each milking unit. The pulsators operate according to the central electronic control unit. This control box adjusts the pulse rate and pulse area, as well as the sequential operation of the pulsators prevent intra-system vacuum fluctuations.

## ÖC.199 Elektronik Pulsatör Panosu - Electronic Pulsator Panel



Elektronik Pulsatör Güç Kaynağı Panosu AC 220 Volt / 50-60 Hz / DC 24 Volt / 10 A Gücünde ve 1-10 Adet Pulsatörün Çalıştırmasında kullanılır.

Electronic Pulsator Power Supply Panel is used in AC 220 Volt / 50-60 Hz / DC 24 Volt / 10 A Power and 1-10 Pulse Pulse Train.

57

# Güğümler ve Aksesuarları

## Buckets and Accessories

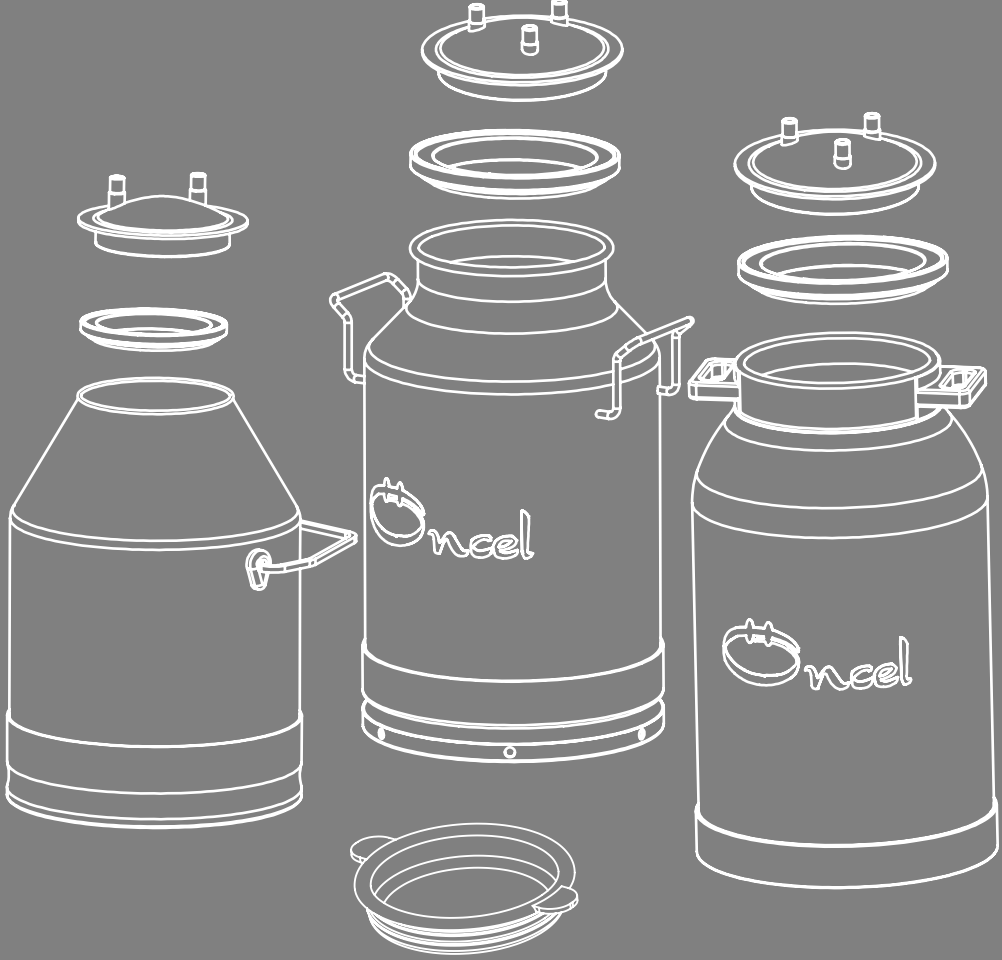



Çeşitli Ebatlardaki güğüm ve ekipmanları iyi bir temizlik elde etmiştir. Sütün temas ettiği her ekipman, bizim için çok önemlidir. Hassasiyet tamamız hijyen ve sağlık esasına dayanmaktadır.

Thoroughly controlling every component that comes in contact with milk is the foremost step in our production. We are precise in terms of hygiene and safety rules.

 Oncel®

**Hijyen ve Sağlık ...**  
**Hygiene and Health ...**

Paslanmaz Süt Güğümleri - Stainless Steel Buckets

		A	H	W
ÖC.113-3	10 Lt.	Ø180 / Ø210 / Ø217	350	4 Kg
ÖC.113-1	20 Lt.	Ø180 / Ø210 / Ø217	365	4,2 Kg
ÖC.113-2	25 Lt.	Ø180 / Ø210 / Ø217	415	4,4 Kg
ÖC.113	30 Lt.	Ø180 / Ø210 / Ø217	465	4,9 Kg
ÖC.112	40 Lt.	Ø180 / Ø210 / Ø217	600	5,9 Kg
ÖC.112-1	50 Lt.	Ø180 / Ø210 / Ø217	720	6,7 Kg

A= Ağız Çapı Opsiyonları / Opening Diameter Optionals (mm)  
H= Yükseklik / Height (mm)  
W= Ağırlık / Weight (Kg)

Tablodaki Hacimlerde, Sabit Saplı Paslanmaz Güğümler 304 L kalite paslanmaz çelikten üretilmiştir.

As it is shown in the chart above, the stainless steel buckets are made of 304 L quality stainless steel

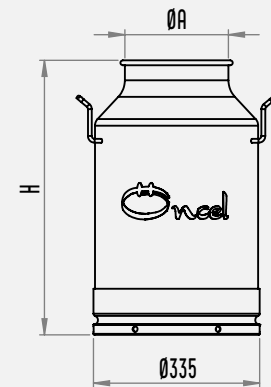

Alüminyum Süt Güğümleri - Aluminium Buckets

		A	D	H	W
ÖC.108-1	10 Lt.	Ø180	Ø250	300	2,0 Kg
ÖC.108-2	20 Lt.	Ø180	Ø300	410	3,1 Kg
ÖC.108-3	25 Lt.	Ø180	Ø300	485	3,5 Kg
ÖC.108	30 Lt.	Ø180	Ø340	580	3,8 Kg
ÖC.107	40 Lt.	Ø217	Ø340	580	4,3 Kg
ÖC.107-1	43 Lt.	Ø217	Ø340	620	4,6 Kg
ÖC.107-2	50 Lt.	Ø217	Ø340	660	5,3 Kg

A= Ağız Çapı Opsiyonları / Opening Diameter Optionals (mm)  
D= Orta Gövde Çapı / Bottom Body Diameter (mm)  
H= Yükseklik / Height (mm)  
W= Ağırlık / Weight (Kg)

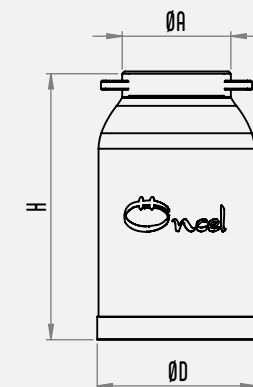

## Klipsli Kapaklı Paslanmaz Süt Güğümleri - With Locking Lid S/S Milk Buckets

	A	D	H	W	
ÖC.209	10 Lt.	Ø180 / Ø210 / Ø217	Ø250	335	4,0 Kg
ÖC.209-1	15 Lt.	Ø180 / Ø210 / Ø217	Ø290	365	4,3 Kg
ÖC.209-2	20 Lt.	Ø180 / Ø210 / Ø217	Ø335	365	4,5 Kg
ÖC.209-3	25 Lt.	Ø180 / Ø210 / Ø217	Ø335	415	4,7 Kg
ÖC.209-4	30 Lt.	Ø180 / Ø210 / Ø217	Ø335	465	5,2 Kg
ÖC.209-5	40 Lt.	Ø180 / Ø210 / Ø217	Ø335	600	6,2 Kg
ÖC.209-6	50 Lt.	Ø180 / Ø210 / Ø217	Ø335	720	7,0 Kg

A= Ağız Çapı Opsiyonları / Opening Diameter Optionals (mm)

D= Orta Gövde Çapı / Bottom Body Diameter (mm)

H= Yükseklik / Height (mm)

W= Ağırlık / Weight (Kg)

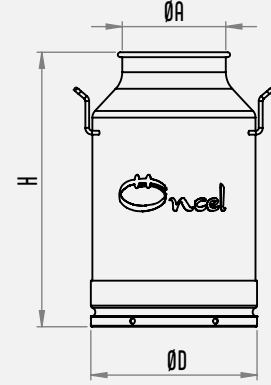

## Klipsli Kapaklı Alüminyum Süt Güğümleri - With Locking Lid Aluminium Milk Buckets

	A	D	H	W	
ÖC.230	10 Lt.	Ø180 / Ø210 / Ø217	Ø250	335	4,0 Kg
ÖC.230-1	20 Lt.	Ø180 / Ø210 / Ø217	Ø335	365	4,5 Kg
ÖC.230-2	25 Lt.	Ø180 / Ø210 / Ø217	Ø335	415	4,7 Kg
ÖC.230-3	30 Lt.	Ø180 / Ø210 / Ø217	Ø335	465	5,2 Kg
ÖC.230-4	40 Lt.	Ø180 / Ø210 / Ø217	Ø335	600	6,2 Kg
ÖC.230-5	50 Lt.	Ø180 / Ø210 / Ø217	Ø335	720	7,0 Kg

A= Ağız Çapı Opsiyonları / Opening Diameter Optionals (mm)

D= Orta Gövde Çapı / Bottom Body Diameter (mm)

H= Yükseklik / Height (mm)

W= Ağırlık / Weight (Kg)

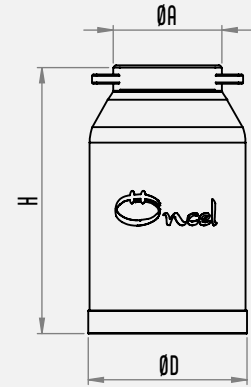

Paslanmaz Süt Ölçekleri / Stainless Steel Milk Measures

	A	D	H	W	
ÖC.110-4	0,5 Lt.	Ø65	Ø80	150	100 Gr
ÖC.110-1	1 Lt.	Ø85	Ø100	190	300 Gr
ÖC.110-2	2 Lt.	Ø110	Ø130	220	400 Gr
ÖC.110-3	5 Lt.	Ø145	Ø160	285	700 Gr

A= Ağız Çapı Opsiyonları / Opening Diameter Optionals (mm)  
 D= Orta Gövde Çapı / Bottom Body Diameter (mm)  
 H= Yükseklik / Height (mm)  
 W= Ağırlık / Weight (Gr)

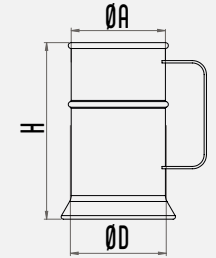

ÖC.109 20 Lt. Galvaniz Süt Ölçeği - 20 Lt. Galvanized Milk Measuring Bucket

Galvaniz süt ölçek kovası 20 Litre. Süt ölçme amaçlı kullanılır. Gıdaya uygun hammaddeden üretilmiştir.

20 liters galvanized milk measures are made from food grade materials and used for milk measurement purposes.



W  
3,9 Kg

ÖC.110 20 Lt. Paslanmaz Süt Ölçeği - 20 Lt. S/S Milk Measuring Bucket

Paslanmaz süt ölçek kovası 20 Litre. Süt ölçme amaçlı kullanılır. Gıdaya uygun hammaddeden üretilmiştir.

20 liters of Stainless Steel milk measures are made from food grade materials and used for milk measurement purposes.



W  
4,8 Kg

AK.010 Alüminyum Kova - Aluminum Cup



Kapasite / Capacity : 10 Litre  
 Taban Çapı / Base Diameter : 200 mm  
 Ağız Çapı / Opening Diameter : 275 mm  
 Boy / Height : 300 mm  
 Ağırlık / Weight : 1 Kg.

AK.001 Alüminyum Süt Kepçesi 1 Lt. - Aluminum Milk Scoop 1 Lt.

AK.005 Alüminyum Süt Kepçesi 0,5 Lt. - Aluminum Milk Scoop 0,5 Lt.



Kapasite / Capacity : 0,5 Litre / 1 Litre  
 Taban Çapı / Base Diameter : 95 mm / 115 mm  
 Ağız Çapı / Opening Diameter : 100 mm / 120 mm  
 Boy / Height : 80 mm / 95 mm  
 Ağırlık / Weight : 178 Gr. / 225 Gr.

## Siyah PVC Taşıma Güğüm Kapakları - Black PVC Carriage Bucket Lid

A

ÖC.021 50 Lt. Ø225

ÖC.022 40 Lt. Ø220

ÖC.023 30 Lt. Ø185

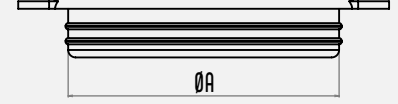
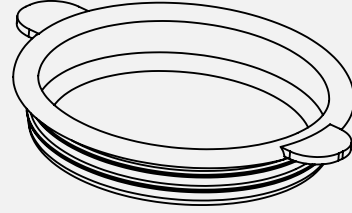

## Beyaz PVC Taşıma Güğüm Kapakları - White PVC Carriage Bucket Lid

A

ÖC.021-1 50 Lt. Ø225

ÖC.022-1 40 Lt. Ø220

ÖC.023-1 30 Lt. Ø185

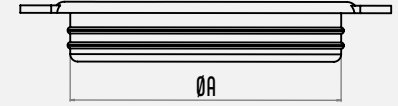
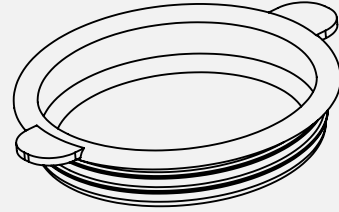

## ÖC.240 Alüminyum Güğüm Kapağı - Aluminium Bucket Lid

40 lt.



## ÖC.240-1 Alüminyum Güğüm Kapağı - Aluminium Bucket Lid

30 lt.





ÖC.015 40 Lt. Polykarbon Güğüm Kapağı - 40 Lt. Polycarbon Bucket Lid

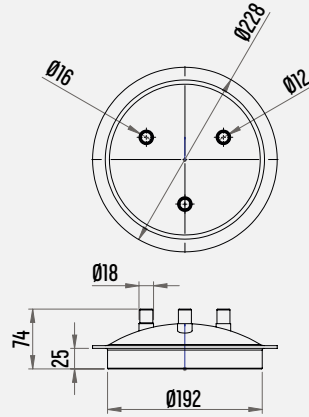

ÖC.041-1 Uyumlu / Only

ÖC.018 30 Lt. Polykarbon Güğüm Kapağı (3 Girişli)- 30 Lt. Polycarbon Bucket Lid (3 Entry)

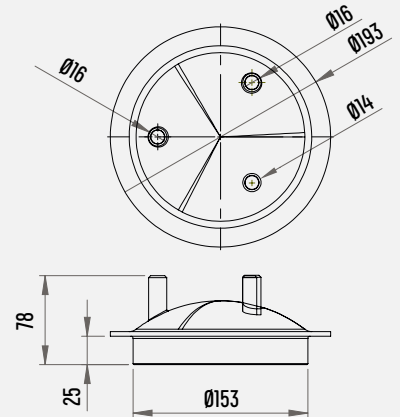

ÖC.042-1 Uyumlu / Only

ÖC.016-1 40 Lt. Polykarbon Düz Güğüm Kapağı - 40 Lt. Polycarbon Flat Bucket Lid

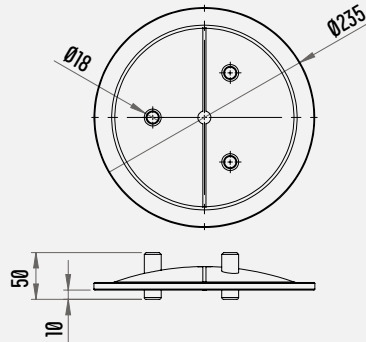

ÖC.043-1 Uyumlu / For Only

ÖC.016 40 Lt. Polykarbon Düz Güğüm Kapağı - 40 Lt. Polycarbon Flat Bucket Lid

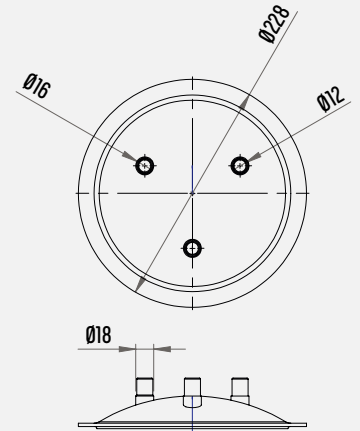

ÖC.043 Uyumlu / Only

ÖC.017 30 Lt. Polykarbon Güğüm Kapağı - 30 Lt. Polycarbon Bucket Lid

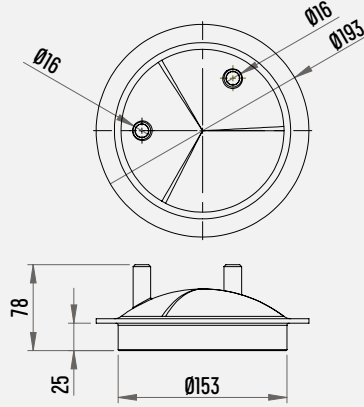

ÖC.042-1 Uyumlu / For Only

ÖC.017-1 30 Lt. Polykarbon Güğüm Kapağı - 30 Lt. Polycarbon Bucket Lid

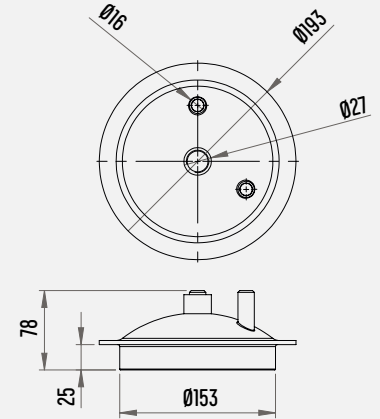

ÖC.042-1 Uyumlu / For Only

ÖC.141 40 Lt. Paslanmaz Güğüm Kapağı - 40 Lt. Stainless Steel Bucket Lid



Malzeme / Material : Inox  
 Ağız Çapı / Opening Diameter : Ø 210  
 Ağırlık / Weight : 740 gr.

Conta Dahildir.  
 The gasket is included.

ÖC.141-1 30 Lt. Paslanmaz Güğüm Kapağı - 30 Lt. Stainless Steel Bucket Lid



Malzeme / Material : Inox  
 Ağız Çapı / Opening Diameter : Ø 180  
 Ağırlık / Weight : 680 gr.

Conta Dahildir.  
 The gasket is included.

## ÖC.019 40 Lt. Paslanmaz Güğüm Kapağı - 40 Lt. Stainless Steel Bucket Lid



3 Girişli - 3 Entry

Malzeme / Material : Inox  
 Ağız Çapı / Opening Diameter : Ø 191  
 Giriş Çapı / Nipple Diameter : Ø17 x Ø13,5  
 Ağırlık / Weight : 995 gr.

Conta Dahildir.  
 The gasket is included.

## ÖC.019-1 40 Lt. Transfer Güğüm Kapağı - 40 Lt. Transfer Bucket Lid



Malzeme / Material : Inox  
 Ağız Çapı / Opening Diameter : Ø 191  
 Giriş Çapı / Nipple Diameter : Ø42 x Ø42  
 Ağırlık / Weight : 895 gr.

Conta Dahildir.  
 The gasket is included.

## ÖC.019-2 40 Lt. Paslanmaz Güğüm Kapağı - 40 Lt. Stainless Steel Bucket Lid



3 Girişli-Yanaklı - 3 Entry-Y

Malzeme / Material : Inox  
 Ağız Çapı / Opening Diameter : Ø 191  
 Giriş Çapı / Nipple Diameter : Ø17 x Ø13,5  
 Ağırlık / Weight : 995 gr.

Conta Dahildir.  
 The gasket is included.

## ÖC.052 40 Lt. Transfer Kapak Contası - Carriage Bucket Gasket



## ÖC.020 30 Lt. Paslanmaz Güğüm Kapağı - 30 Lt. Stainless Steel Bucket Lid



3 Girişli-Yanaklı - 3 Entry-Y

Malzeme / Material : Inox  
 Giriş Çapı / Nipple Diameter : Ø17x2 - Ø15x1,5  
 Ağırlık / Weight : 1030 gr.  
 Kullanım alanı, 30 Lt. Alüminyum ve Paslanmaz Çelik Kilitli Güğümlerde, 1 Adet Başlık Bağlanabilir.  
 Place of Use, 30 Lt. Aluminum and Stainless Steel For Clamp Bucket, 1 Piece Milk Cluster

## ÖC.020-1 30 Lt. Paslanmaz Güğüm Kapağı - 30 Lt. Stainless Steel Bucket



Malzeme / Material : Inox  
 Ağız Çapı / Opening Diameter : Ø 185  
 Giriş Çapı / Nipple Diameter : Ø42 x Ø42  
 Ağırlık / Weight : 995 gr.

Conta Dahildir.  
 The gasket is included.

## ÖC.139 40 Lt. Paslanmaz Güğüm Kapak Contası - 40 Lt. Stainless Steel Bucket Lid Gasket

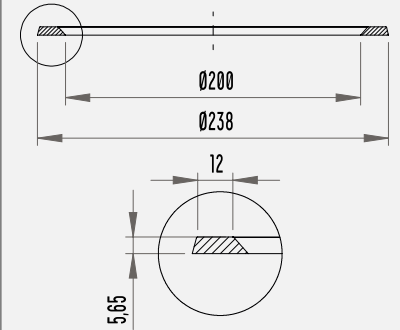

ÖC.041-1 40 Lt. Güğüm Kapağı Contası PVC - 40 Lt. Bucket Lid Gasket PVC

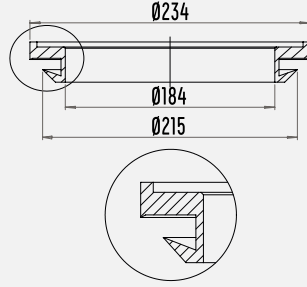

ÖC.044 30 Lt. Düz Güğüm Kapağı Contası - 30 Lt. Flat Bucket Lid Gasket



Kauçuk / Rubber

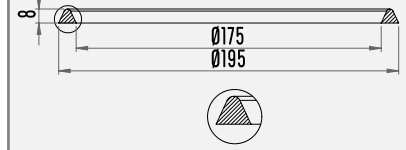

ÖC.042-1 30 Lt. Güğüm Kapağı Contası PVC - 30 Lt. Bucket Lid Gasket PVC

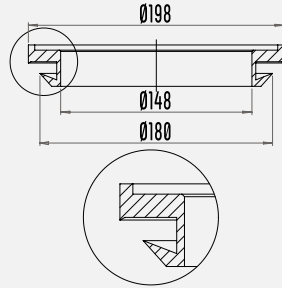

ÖC.044-1 30 Lt. Düz Güğüm Kapağı Beyaz Contası - 30 Lt. Flat Bucket Lid White Gasket



PVC / PVC

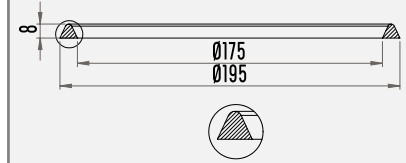

ÖC.043 40 Lt. Düz Güğüm Kapağı Contası - 40 Lt. Düz Bucket Lid Gasket

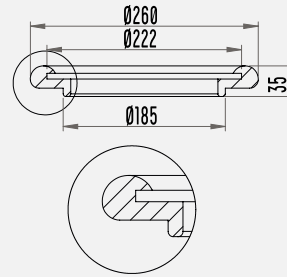

ÖC.044-2 30 Lt. Düz Güğüm Kapağı Contası - 30 Lt. Flat Bucket Lid Gasket



Kauçuk / Rubber

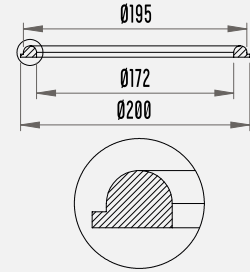

ÖC.043-1 40 Lt. Düz Güğüm Kapağı Contası - 40 Lt. Flat Bucket Lid Gasket

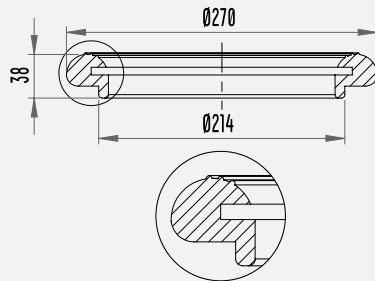

ÖC.045 30 Lt. Düz Güğüm Kapağı Contası - 30 Lt. Flat Bucket Lid Gasket



Kauçuk / Rubber

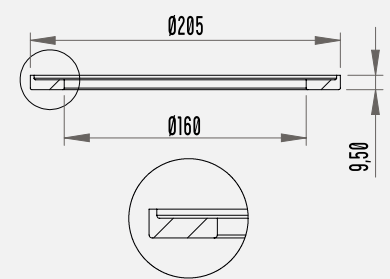



# Vakum Pompaları ve Aksesuarları

## Vacuum Pumps and Accessories

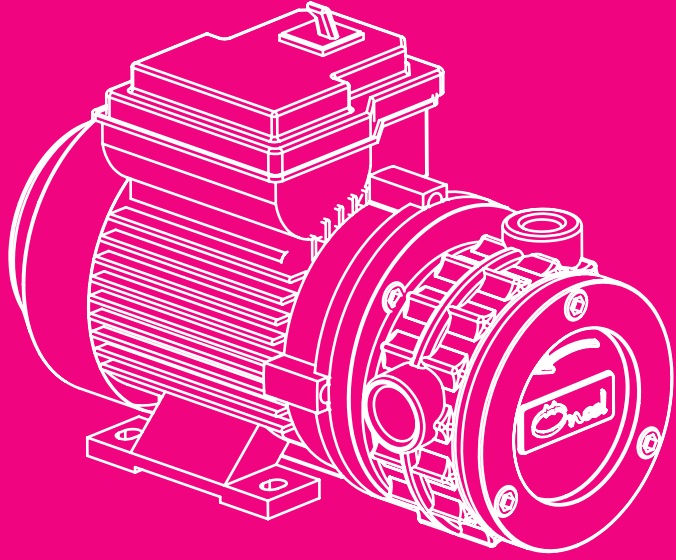



Vakum Pompaları ve aksesuarları, Gerçekleştirilecek olan sağımın, sağım kapasitesine bağlı olarak vakum ihtiyacını karşılamak için kullanılan ürün grubudur.

A product group that is used to meet the vacuum requirement according to the milking capacity of the milking to be done.



**Stabil Çalışma...**  
**Working Properly...**

[www.oncelmak.com](http://www.oncelmak.com)



#oncelmakina

## Vakum Pompaları- Vacuum Pumps

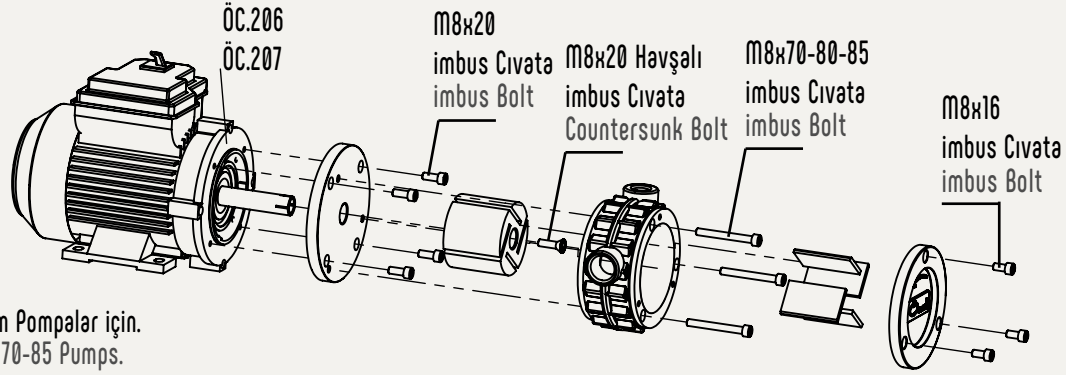

Ürün Teknik Detayları - 70-85mm Pompalar için.  
Product Technical Details - For 70-85 Pumps.

## Vakum Pompa Setleri / Vacuum Pump Sets

ÖC.078 70 mm Kuru Tip Pompa Seti / 70 mm Dry Type Pump Set

ÖC.099 70 mm Yağlı Tip Pompa Seti / 70 mm Oil Type Pump Set

ÖC.203 80 mm Kuru Tip Pompa Seti / 80 mm Dry Type Pump Set

ÖC.203-1 80 mm Yağlı Tip Pompa Seti / 80 mm Oil Type Pump Set

ÖC.204 85 mm Kuru Tip Pompa Seti / 85 mm Dry Type Pump Set

ÖC.204-1 85 mm Yağlı Tip Pompa Seti / 85 mm Oil Type Pump Set

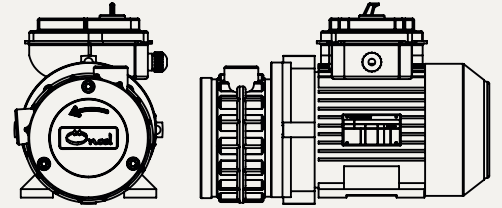

## Elektrik Motoru - Electric Engine

ÖC.206 0,55 Kw. 1500 d/d. 220-230V. 50 Hz

ÖC.207 0,75 Kw. 1 Hp. 1500 d/d. 220-230V. 50 Hz

Opsiyonel - 110-120V 60Hz (Priz tipi Üçlü - A/B)

Optional - 110-120V 60Hz (Plug Type - A/B)



Standart Priz (F Tipi)  
Plug (F Tip)



ÖC.251 Şalter Kutusu Set  
Switch Box Set



ÖC.054 Plastik Motor Mil Muhafazası  
Plastic Engine Shaft Cover



İsteğe bağlı farklı renkte üretilebilir.  
The optional color may vary.

ÖC.251-1 220V Şalter  
220V Switch



ÖC.251-2 0.55 kW Kondansatörü  
0.55 kW Capacitor



12 mf

Kuru Tip Vakum Pompası Grafit Paletleri / Dry Type Vacuum Pump Graphites Palette

	A	B	C
ÖC.115	4,85	85	41
ÖC.115-1	4,70	85	43
ÖC.116	4,93	70	43
ÖC.116-1	4,9	80	43
ÖC.116-2	4,9	75	43
ÖC.117	5,95	70	46
ÖC.117-1	5,90	62	41
ÖC.118	4,95	65	40
ÖC.118-1	4,9	86	40
ÖC.119	4,9	70	41,5



Palet Kömür Takımı 4 Adettir.  
Pallet Graphite Set (4 Pcs.)

Yağlı Tip Vakum Pompası Fiber Paletleri / Oil Type Vacuum Pump Fiber Palette

65-85 mm	A	B	C
ÖC.120	4,93	70	43
ÖC.120-1	4,90	80	43
ÖC.121	5,95	70	46
ÖC.122	4,90	70	41,5
ÖC.123	4,95	65	40
ÖC.123-1	4,85	85	41
ÖC.180	5,9	85	55

100-250 mm	A	B	C
ÖC.176	4,9	43	100
ÖC.177	4,9	43	150
ÖC.178	4,9	43	200
ÖC.179	4,9	43	250

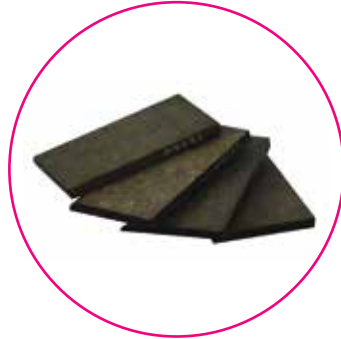

Palet Kömür Takımı 4 Adettir.  
Pallet Graphite Set (4 Pcs.)

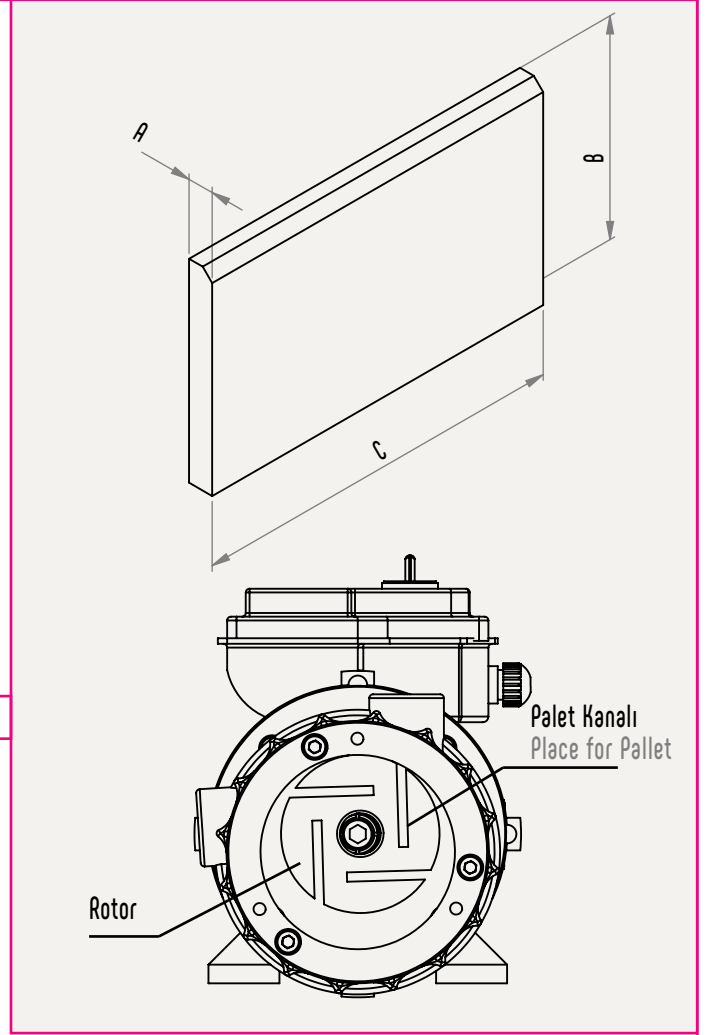



ÖC.268 70 Lik Plastik Tip Susturucu Seti - 70 Plastic Type Silencer Set



ÖC.058 70 Lik Kuru Tip Susturucu  
70 Dry Type Silencer



ÖC.058-1 85 Lik Kuru Tip Susturucu  
85 Dry Type Silencer



ÖC.059 70 Lik Yağlı Tip Susturucu  
70 Oil Type Silencer



ÖC.059-1 85 Lik Yağlı Tip Susturucu  
85 Oil Type Silencer



ÖC.063 Plastik Motor İzolasyon Pulu  
Engine isolated Plastic Rove



ÖC.063-1 Plastik Motor İzolasyon Pulu  
Engine isolated Plastic Rove



ÖC.197 0,5 Lt. Yağdanlık  
0,5 Lt. Lubricator



ÖC.241 70 Lik Yağlı Tip Susturucu Seti  
70 Oil Type Silencer Set



ÖC.173-6



ÖC.173-7

ÖC.173-1/A Yağ Atık Kabı Üst Kapak - Lubricator Waste Upper Lid

ÖC.173-3 Yağdanlık Tamir Takımı (Pirinç)  
Lubricator Repair Kit (Brass)



Yağ Emici  
Oil Receiver

ÖC.173-3/A



Yağ Emici Rekoru  
Oil Receiver Rekor

ÖC.173-3/B

Yağdanlık - Lubricator (1 Giriş- 1 Entry)

ÖC.173/A

Yağ Atık Kabı Haznesi - Lubricator Waste Box Cup

ÖC.173-7

Yağ Atık Kabı - Lubricator Waste Box

ÖC.173-1

Yağdanlık - Lubricator (2 Giriş- 2 Entry)

ÖC.173

## Vakum Tank Modelleri Vacuum Tank Model



Tank Kapağı, Akıtma Sbobu , Regülatör Dahil Değildir.  
Tank Lid ,Discharge Plug, Regulator are not included.

● Opsiyonel isteğe bağlı Boyanabilir.  
○ Colors are optional.

Kod Code	Kapasite Capacity	Tip	Model
ÖC.039	17 lt.	Kuru	Ş.Mod.
ÖC.039-1	17 lt.	Kuru	K.K. Mod.
ÖC.039-2	17 lt.	Kuru	Ç.Mod
ÖC.039-3	17 lt.	Kuru	Borulu
ÖC.039-4	17 lt.	Kuru	K. Yağlı
ÖC.039-5	17 lt.	Kuru	K.Sabit
ÖC.039-6	17 lt.	Kuru	S. Mod.
ÖC.039-7	17 lt.	Kuru	B. Mod.
ÖC.039-8	17 lt.	Kuru	<b>Standart</b>
ÖC.039-9	17 lt.	Kuru	Ters Çıkışlı (85Lik)
ÖC.040	17 lt.	Yağlı -Turbo	<b>Standart</b>

## ÖC.034 Vakum Tank Kapağı (Komple) - Vacuum Tank Lid (Complete)

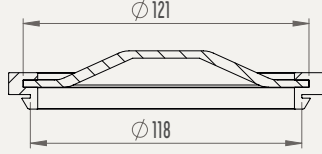
ÖC.033 Vakum Tank Kapağı  
Vacuum Tank Lid

● İsteğe bağlı farklı renkte üretilebilir.  
● Color may vary due to order

ÖC.046 Vakum Tank Kapak Contası (PVC)  
Vacuum Tank Lid Gasket (PVC)

## ÖC.036/A Regülatör - Regulator



## ÖC.036 Regülatör - Regulator



## ÖC.037 Tahliye Tapası - Discharge Plug



## YM.136 Körtapa 1/2"- Plug 1/2"





ÖC.184	70 Lik Çekvalf Seti Kuru 70 Check Valve Set Dry
ÖC.184/A	70 Lik Çekvalf Seti Yağlı 70 Check Valve Set Oily
ÖC.205	85 Lik Çekvalf Seti Kuru 85 Check Valve Set Dry
ÖC.205/A	85 Lik Çekvalf Seti Yağlı 85 Check Valve Set Oily



ÖC.270	Dirsekli Çekvalf Kuru - Elbow Check Valve Dry
ÖC.270-1	Dirsekli Çekvalf Yağlı - Elbow Check Valve Oily



ÖC.184-1	Kauçuk Çekvalf Bilyası Rubber Check Valve Ball
ÖC.184-1/A	Metal Çekvalf Bilyası Metal Check Valve Ball

ÖC.184-2	Çekvalf Pulü Check Valve Rove
----------	----------------------------------



ÖC.252	90° Kuyruklu Dirsek 90° Elbow tube Connector
--------	--



1/2"-3/4"

ÖC.038	Ø63 Vakum Saati Ø63 Vacuum Meter
--------	-------------------------------------



ÖC.038-1	Ø100 Vakum Saati Ø100 Vacuum Meter
----------	---------------------------------------



ÖC.153	Kauçuk Vakum Ara Hortumu - Rubber Vacuum Mediate Tube
--------	---

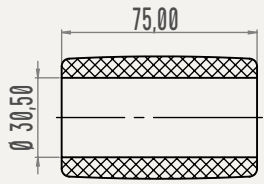

ÖC.153-1	Kısa Tip Vakum Ara Hortumu - Short Type Vacuum Mediate Tube
----------	---

ÖC.267	Eko Vakum Ara Hortumu - Eko Vacuum Mediate Tube (Ø25-Ø27)
--------	---

ÖC.035 Polykarbon Düz Vakum Tank Kapağı - Polycarbonate Flat Vacuum Tank Lid

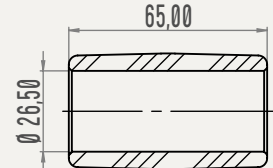

ÖC.047 Düz Vakum Tank Kapak Contası - Flat Vacuum Tank Lid Gasket



ÖC.035-1 Polykarbon Vakum Tank Kapağı - Polycarbonate Vacuum Tank Lid



ÖC.049 Vakum Tank Kapağı Contası - Vacuum Tank Lid Gasket

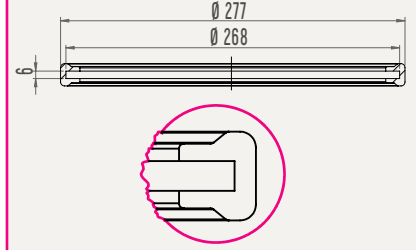

ÖC.048 Vakum Tank Kapağı Contası (Kauçuk) - Vacuum Tank Lid Gasket (Rubber)



ÖC.050 Vakum Tank Kapağı Contası (Kauçuk) - Vacuum Tank Lid Gasket (Rubber)

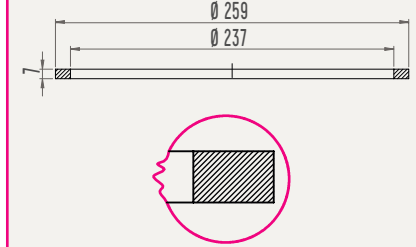

ÖC.051 Vakum Tank Kapağı Contası (Kauçuk) - Vacuum Tank Lid Gasket (Rubber)

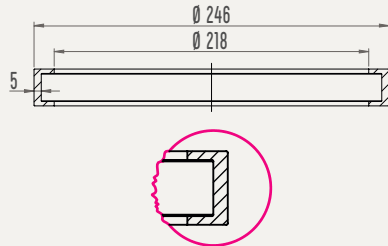

ÖC.037-1 Vakum Tank Klapesi - Vacuum Tank Flap



7

# Sağım Sistemi Aksesuarları

## Milking System Accessories

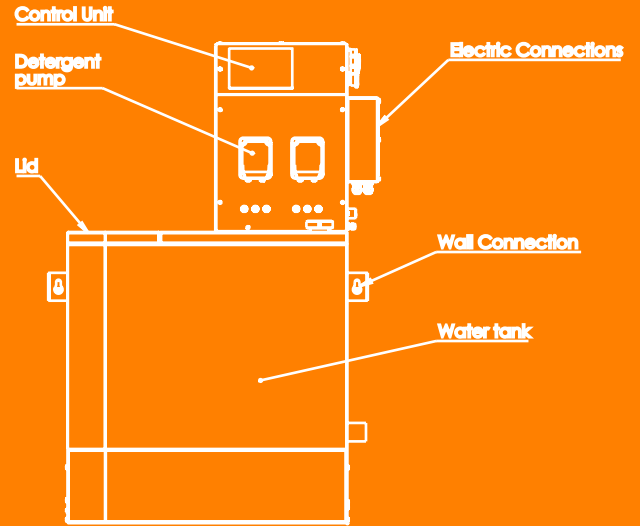
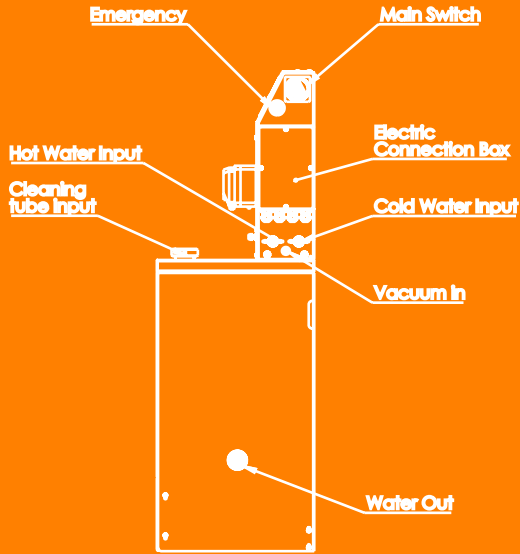



Süt sađımı bir sađım çiftliđindeki en hassas ve en önemli ařamalardan birisidir. İyi bir hayvan sađlıđı garanti etmek, stresi önlemek, süt verimini ve kalitesini optimize etmek esastır.

Hızlı ve komple bir süt sađım prosesi garanti etmek ayrıca süt sađım işlemleri esnasında operatörlerin konforu ve güvenliđi açısından da hayatidir. En kaliteli sonuçlarla yüksekperformanslı süt sađımını garanti etmek ve müşteri kullanımını kolaylařtırmak için Milkline'ın beř süt sađım sistemi en iyi teknolojileri sunar.

Tedarikçilerden ve distribütörlerden oluşan ehil ve profesyonel ekip size planlı kontrollerde destek verecek. Ayrıca istikrarlı optimal inek performans seviyelerinin sađlanması için size acil durumlarda da anında destek sađlayacaklar.

Milking is one of the most sensitive and important stages in milking farm. It is important to guarantee a good animal health to prevent stress, to optimize milk volume and quality. The guarantee of a fast and complete milking process depends especially on operators' comfort and safety. We offer high quality milking systems that provide high performance in delivering top quality results. Our competent and professional team is always ready to support our suppliers and distributors in intended monitorings. Moreover, our team shows its interest in helping our customers on improving livestock performance and health that result in milk quality.



**En Uygun, En Kaliteli...**

**Best Available, Best Quality ...**

[www.oncelmak.com](http://www.oncelmak.com)



#oncelmakina

ÖC.1100 Süt Aktarma Seti - Milk Transfer Set



Aktarma Pompası - Transfer Pump

ÖC.164-1 1,5Hp / 2800 D/Dk / 1,1Kw / 220V Monofaze

ÖC.164 1,5Hp / 2800 D/Dk / 1,1Kw / 380V Trifaze



ÖC.261 Aktarma Pompa Vanası  
Transfer Pump Valve



ÖC.164-A Aktarma Pompa Klepesi  
Transfer Pump Flap



ÖC.164-B Aktarma Pompa Klepesi-Kauçuk  
Transfer Pump Flap-Rubber



Aktarma Pompası Kontrol Panosu - Transfer Pump Control Box

ÖC.182-1 1,5Hp / 2800 D/Dk / 1,1Kw / 220V Monofaze

ÖC.182-2 1,5Hp / 2800 D/Dk / 1,1Kw / 380V Trifaze

ÖC.182 Sistem Kontrol Pano - System Control Box



ÖC.181/A Seviye Tespit Çubuk Seti - Inox Şamandıralı  
Milk Level Sensor - Inox Buoy

ÖC.181 Seviye Tespit Çubuk Seti - Pls. Şamandıralı  
Milk Level Sensor - Plastic Buoy

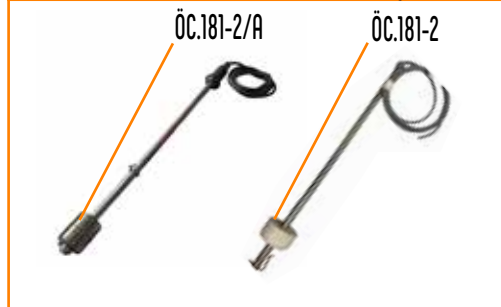

ÖC.164-3

Aktarma Pompa Keçesi  
Milk Pump Seal



## Ön Süt Toplama Tankı (İnox) - Milk Tank (S/S)

		ØA	B	ØC	ØD
ÖC.163	60 Lt.	Ø40	Ø40	Ø40	Ø500
ÖC.163-1	40 Lt.	Ø40	Ø40	Ø40	Ø500
ÖC.163-3	50 Lt.	Ø40	Ø40	Ø40	Ø500
ÖC.163-4	30 Lt.	Ø40	Ø40	Ø40	Ø500
ÖC.163-5	100 Lt.	Ø40	Ø40	Ø40	Ø500

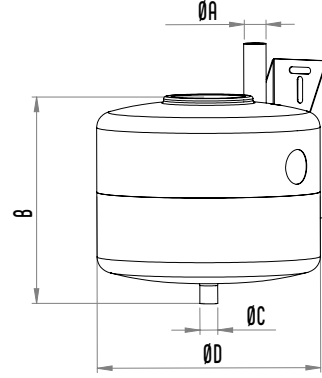

## ÖC.163-2 Rezerve Kapak - Tank Lid



Malzeme / Material :İnox - Inox

## ÖC.165 Cam Fanus- Milk recorder jar



8lt.

## ÖC.165-A Cam Fanus- Milk recorder jar



5lt.

## ÖC.165-1 Fanus Camı - Glass jar



## ÖC.165-2 Fanus Topu - Jar Ball



## ÖC.140 Rezerve Tapa - Tank Plug



## ÖC.166 Ø40 Paslanmaz Süt Filtresi - Ø40 Stainless Steel Milk Filter



## ÖC.211 Kağıt Süt Filtresi - Paper Milk Filter



Paket / Package : 100 Adet/ Pcs.

ÖC.269 Süt Aktarma Borusu  
Milk Transfer Pipe

İnox - S/S

## ÖC.166-A Ø40 Paslanmaz Dirsekli Süt Filtresi - Ø40 Stainless Steel Bracket Milk Filter





ÖC.181-1 Seviye Tespit Çubuk Tapası  
Sensor Plug



ÖC.181-2/A Seviye Tespit Şamandırası  
Level Sensor Buoy



İnox - Inox

ÖC.183 Otomatik Çıkarıcı  
Automatic Cluster Remover



ÖC.189 Mekanik Süt Ölçer  
Mechanic Milk Meter



ÖC.239 Servo Vakum Regülatör - Servo Vacuum Regulator



Kapasite : 50-3500 Lt/dk (30-60 Kpa)  
Sağım sürecinde vakum istikrarını, kolay ayarını sağlar,uzun ömürlüdür.  
Capacity: 50-3500 Lt / min (30-60 Kpa)  
Provides vacuum stability, easy adjustment and long service life in milking process.

ÖC.202 Vakummatik - Vacuummatic



Yağlı ve Kuru Tip Vakum Pompalarının, İstenilen Vakum değerlerini istikrarını koruyarak ayarlar.  
Adjusts the Vacuum Pumps of Oil and Dry Type by maintaining their desired vacuum values.



ÖC.202-1 Vakummatik Diyafram  
Vacuummatic Diaphragm

ÖC.086 Daldırma Kabı Sağımdan Önce  
Dip Case After Milking



ÖC.086-1 Daldırma Kabı Sağımdan Sonra  
Dip Case Before Milking



ÖC.232 Yatay Boru Bağlantı Aparatı  
Horizontal Pipe Connection Apparatus



ÖC.233 Dikey Boru Bağlantı Aparatı  
Vertical Pipe Connection Apparatus

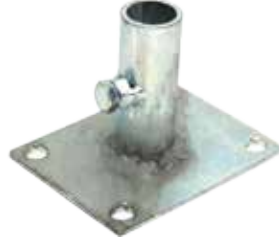

ÖC.234 Aktarma Motor Bağlantı Aparatı - Transfer Motor Holder

1 Adet / Pc.



ÖC.235-1 Duvar Bağlantı Aparatı  
L pipeline hanger



20cm

ÖC.235-2 Duvar Bağlantı Aparatı  
L pipeline hanger



25cm

ÖC.235 Duvar Bağlantı Aparatı  
L pipeline hanger



10cm

ÖC.151 Askı Demiri - Hanger



Inox

ÖC.235-3 U Civata - U Bolt 1 1/2"



ÖC.236 Boru Kistirme Aparatı - Pipe Clamping Apparatus

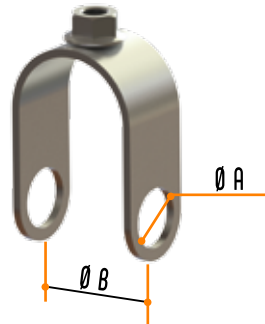

	A	B
ÖC.236	1/2"	1"
ÖC.236-1	1/2"	1 1/4"
ÖC.236-2	1/2"	1 1/2"

ÖC.162 Düz Süt Girişi - Flat Milk Entry



Inox

ÖC.162-1 90° Süt Girişi - 90° Flat Milk Entry



Inox

ÖC.162-2 180° Süt Girişi - 180° Flat Milk Entry



Inox

Süt Giriş Kelepçe Aksesuarları  
Milk Entry Clamp Accessories



ÖC.162-3



Inox  
ÖC.162-4

ÖC.195 Düz Süt Girişi Kelepçesi  
Flat Milk Entry Clamp



Inox

ÖC.195-1 90° Süt Girişi Kelepçesi  
90° Flat Milk Entry Clamp



Inox

ÖC.195-2 180° Süt Girişi Kelepçesi  
180° Flat Milk Entry Clamp



Inox

Süt Girişi Kelepçe Contaları  
Milk Entry Clamp Gaskets



ÖC.195-B



ÖC.195-A

ÖC.196 Vakum Musluk Seti  
Vacuum Tap Set



Vakum Musluk Seti Aksesuarları - Vacuum Tap Set Accessories

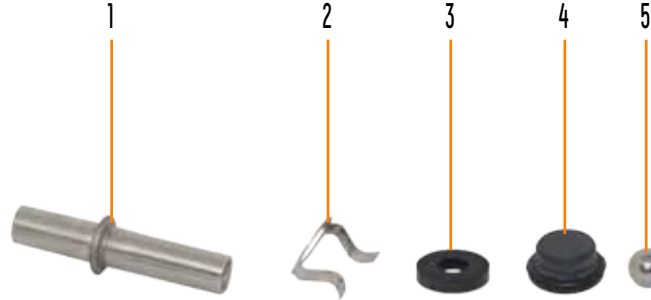

1	ÖC.196-1	Vakum Musluk Çıkışı (Inox) - Vacuum Tap Exit (Inox)
2	ÖC.196-2	Vakum Musluk Çıkışı Klipsi (Inox) - Vacuum Tap Exit Clamp (Inox)
3	ÖC.196-3	Vakum Musluk Contası - Vacuum Tap Gasket
4	ÖC.196-4	Vakum Musluk Tapası - Vacuum Tap Plug
5	ÖC.196-5	Vakum Musluk Bilyesi - Vacuum Tap Exit Ball

Paslanmaz Boru Kelepçesi  
Stainless Steel Tube Clamp



ØD

ÖC.167 Ø30

ÖC.167-1 Ø40

ÖC.167-2 Ø50

## Kauçuk Dirsekler - Rubber Tube Connector Elbows

	ØD	Ød
ÖC.150	Ø40	Ø40
ÖC.150-1	Ø50	Ø50
ÖC.150-2	Ø30	Ø30
ÖC.150-3	Ø50	Ø40
ÖC.150-4	Ø70	Ø70
ÖC.150-5	Ø63	Ø63

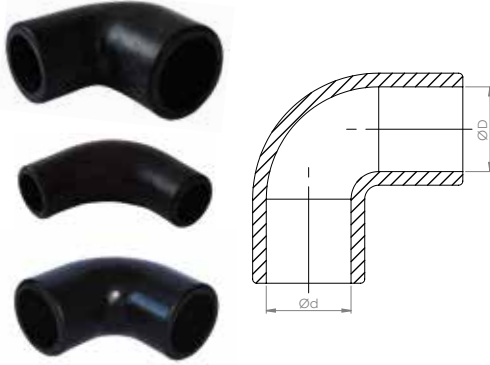

## Kauçuk Körtapa - Rubber Plug



ÖC.161 Ø40

ÖC.161-1 Ø50

## Paslanmaz Çıkışlı Kauçuk Körtapa - Stainless Steel Exit Rubber Plug

	ØD
ÖC.193	Ø40
ÖC.193-1	Ø50

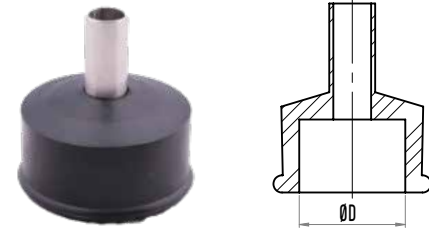

## Kauçuk Redüksiyonlar - Rubber Reductions

	ØD	Ød
ÖC.152	Ø32	Ø20
ÖC.152-1	Ø50	Ø40
ÖC.152-2	Ø50	Ø32
ÖC.152-3	Ø75	Ø70
ÖC.152-4	Ø90	Ø70
ÖC.152-5	Ø70	Ø50
ÖC.152-6	Ø63	Ø50



## ÖC.160-5 Sistem Kauçuk TE - System Rubber TE



## Kauçuk Mânşon - Rubber Muff

	ØD
ÖC.160	Ø32
ÖC.160-1	Ø40
ÖC.160-2	Ø50
ÖC.160-3	Ø75
ÖC.160-4	Ø63

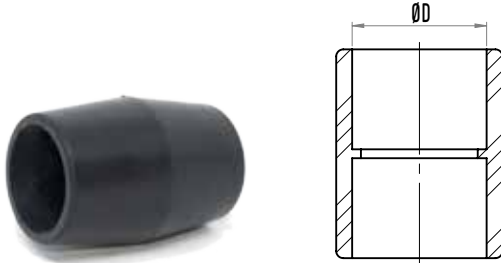

## ÖC.149 Kauçuk Katriş Dirsek - Rubber Katris Bracket

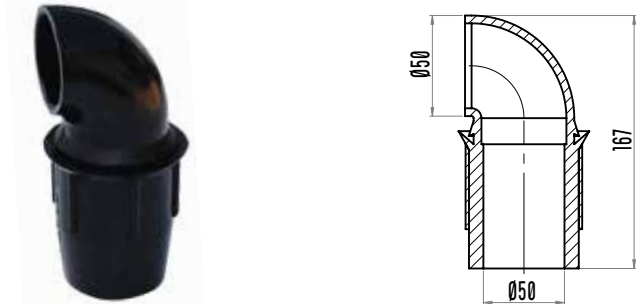

Plastik Priz Kolye - Plastic Saddle Clamp

ÖC.237 Ø40x1/2"

ÖC.237-1 Ø40x3/4"

ÖC.237-2 Ø40x1"

ÖC.238 Ø50x1/2"

ÖC.238-1 Ø50x3/4"

ÖC.238-2 Ø50x1"

ÖC.239 Ø63x1/2"

ÖC.239-1 Ø63x3/4"

ÖC.239-2 Ø63x1"

ÖC.253 Ø75x1/2"

ÖC.253-1 Ø75x3/4"

ÖC.253-2 Ø75x1"

ÖC.254 Ø90x1/2"

ÖC.254-1 Ø90x3/4"

ÖC.254-2 Ø90x1"

ÖC.25 5 Ø110x1/2"

ÖC.255-1 Ø110x3/4"

ÖC.255-2 Ø110x1"



UH-PVC Yapıştırma Muflu Kör Tapa  
UH-PVC Solvent Cement End Cap

ØD

ÖC.257-5 Ø40

ÖC.257 Ø50

ÖC.257-1 Ø63

ÖC.257-2 Ø75

ÖC.257-3 Ø90

ÖC.257-4 Ø110

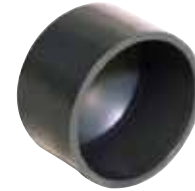

U-PVC Yapıştırma Muflu Küresel Vakum Vanası  
U-PVC Solvent Cement True Union Ball Valve For Vacuum

ØD

ÖC.258 Ø50

ÖC.258-1 Ø63

ÖC.258-2 Ø75

ÖC.258-3 Ø90

ÖC.258-4 Ø110



Plastik Dirsek 90° - 90° Plastic Elbow

ØD

ÖC.259-8 Ø40

ÖC.259 Ø50

ÖC.259-1 Ø63

ÖC.259-2 Ø75

ÖC.259-3 Ø90

ÖC.259-4 Ø110



Plastik Kelepçe - Plastic Clamp

ØD

ÖC.260 Ø40

ÖC.260-1 Ø50

ÖC.260-2 Ø63

ÖC.260-3 Ø75

ÖC.260-4 Ø90

ÖC.260-5 Ø110



## PVC T - PVC T

	ØD
ÖC.263	Ø40
ÖC.263-1	Ø50
ÖC.263-2	Ø63
ÖC.263-3	Ø75
ÖC.263-4	Ø90
ÖC.263-5	Ø110



## PVC Manşon - PVC Sleeve

	ØD
ÖC.261-5	Ø40
ÖC.261	Ø50
ÖC.261-1	Ø63
ÖC.261-2	Ø75
ÖC.261-3	Ø90
ÖC.261-4	Ø110



## UH-PVC Yapıştırma Mufllu Kolye - UH-PVC Solvent Cement Flange Adaptor

	ØD
ÖC.265	Ø50
ÖC.265-1	Ø63
ÖC.265-2	Ø75
ÖC.265-3	Ø90
ÖC.265-4	Ø110



## UH-PVC Rakor UH-PVC Union

	ØD
ÖC.266	Ø50
ÖC.266-1	Ø63
ÖC.266-2	Ø75
ÖC.266-3	Ø90
ÖC.266-4	Ø110



ÖC.256-1 1/2" Plastik Uç  
1/2" Plastic

ÖC.256-3 3/4" Plastik Uç  
3/4" Plastic



ÖC.256 1/2" Prinç Uç  
1/2" Brass

ÖC.256-2 3/4" Prinç Uç  
3/4" Brass



ÖC.143 Yıkama Başlığı Komple - Washing Cluster Complete



ÖC.271 Yıkama Başlığı Komple - Washing Cluster Complete



ÖC.210-1 Yıkama Başlığı Komple  
Washing Cluster Complete



ÖC.210 Yıkama Başlığı Komple  
Washing Cluster Complete



ÖC.210-2 Yıkama Başlığı Komple Katlanabilir - Washing Cluster Complete



ÖC.188-1 Yıkama Başlığı Komple - Washing Cluster Complete



ÖC.143-2 Yıkama Başlığı Komple - Washing Cluster Complete



ÖC.188 Yıkama Başlık seti (F Tipi)  
Washing Cluster Set (F Type)



●● Opsiyonel İsteğe bağlı farklı renkte Üretilebilir.  
●● Optional The optional color vary.

ÖC.148-4 Yıkama Başlık Gövde (F Tipi)  
Washing Cluster Body (F Type)



●● Opsiyonel İsteğe bağlı farklı renkte Üretilebilir.  
●● Optional The optional color vary.

ÖC.146-3 Yıkama Başlık Tapa Sabitleyici (F Tipi)  
Washing Cluster Plug Stabilizer (F Type)



●● Opsiyonel İsteğe bağlı farklı renkte Üretilebilir.  
●● Optional The optional color vary.

ÖC.145-2 Yıkama Başlık Çubuğu (F Tipi)  
Washing Cluster Stick (F Type)



●● Opsiyonel İsteğe bağlı farklı renkte Üretilebilir.  
●● Optional The optional color vary.

ÖC.143-1 Yıkama Başlık Seti  
Washing Cluster Set



●● Opsiyonel İsteğe bağlı farklı renkte Üretilebilir.  
●● Optional The optional color vary.

ÖC.148-1 Yıkama Başlık Gövde  
Washing Cluster Body



●● Opsiyonel İsteğe bağlı farklı renkte Üretilebilir.  
●● Optional The optional color vary.

ÖC.145-1 Yıkama Başlık Çubuğu  
Washing Cluster Stick



●● Opsiyonel İsteğe bağlı farklı renkte Üretilebilir.  
●● Optional The optional color vary.

ÖC.145 Yıkama Başlık Çubuğu  
Washing Cluster Stick



●● Opsiyonel İsteğe bağlı farklı renkte Üretilebilir.  
●● Optional The optional color vary.

ÖC.146-1 Yıkama Başlık Tapası  
Washing Cluster Plug



ÖC.146 Yıkama Başlık Tapası  
Washing Cluster Plug



ÖC.146/A Yıkama Başlık Tapası-Büyük  
Washing Cluster Plug-Big

ÖC.147 Yıkama Başlık Hortumu  
Washing Cluster Tube



ÖC.148 Yıkama Başlık Kelepçesi  
Washing Cluster Clamp





ÖC.148-2 Yıkama Başlık Somunu  
Washing Cluster Nut



ÖC.148-2/A Yıkama Başlık Somunu  
Washing Cluster Nut



ÖC.147-1 Yıkama Başlık Dağıtıcı  
Washing Cluster Distributor



ÖC.147-2 Yıkama Başlık Dağıtıcı  
Washing Cluster Distributor



ÖC.148-3 Yıkama Başlık Ayağı (Kısa Tip)  
Washing Cluster Stand (Short Type)



ÖC.250-1 Yıkama Başlık Portatif Standı  
Washing Cluster Portable Stand

L=600mm

ÖC.250-1/A Yıkama Başlık Portatif Standı  
Washing Cluster Portable Stand

L=1000mm



ÖC.250 Yıkama Başlık Kızağı (Komple) - Washing Cluster Stand (Complete)



ÖC.148-3/A Yıkama Başlık Ayağı (Katlanabilir) - Washing Cluster Stand (Floding)





### Öncel Yıkama Otomatı

#### Özellikler

Temizleme otomatı , boru hattı sağım tesisatlarının hijyen hale getirilmesinde, günümüz teknolojisinde kolaylık sağlar . Süt hattı sisteminin, otomatik olarak temizlenmesi için kullanılır. Esnek elektronik kontrollü program kendini sağım tesisatına dayalı olarak mümkün olan en iyi şekilde ayarlar, en iyi temizliği sağlar. Tüm temizlik bilgilerini ileriye dönük olarak analiz eder.

#### Temizlik otomatı

- Süt taşıma parçalarının iyi temizlenmesi
- En uygun su miktarının belirlenmesi ve tutulması

#### Temizleme maddesinin tam oranı

#### Temizlik maddesinin tekrarlanması

- Programın zaman kontrollü aktivasyonu "Ön temizleme"

#### İkinci vakum yüksekliğinin başlangıç sinyali

#### Birkaç harici temizleyicinin kontrolü

- Tüm sürecin görüntülenmesi

- kolay kurulum

#### 2 satır, 16 karakter görüntüler

#### arka plan aydınlatması

#### Ortam havası sıcaklığı 0 ... 45 ° C

#### Kurulumda ayarlanabilen program akış parametreleri

#### Su Girişi 2x ¾ "

#### Giriş : DN 50

#### Çıkış : DN 45

#### Süper güç: 220V AC

#### Şasi: S / S

#### Kontrol Paneli: PIC Entegre Sistemi

#### Isıtma: Yok

### Öncel Washing Machine

#### Features

The washing machine provides an easy washing of pipeline milking installations. It is used for automatic cleaning of milk line systems. The flexible electronically controlled program adjusts itself as best as possible based on the milking system, providing the best cleaning possible. Analyzes all cleaning information prospectively.

#### Cleaning machine

- Good cleaning of milk conveying parts
- Determination and retention of the most appropriate amount of water

#### The exact ratio of cleaning agent

#### Repeating of cleaning agent

- Time controlled activation of the program

#### "Pre-cleaning"

#### Start signal of second vacuum height

#### Control of several external cleaners

- Viewing the entire process

- easy setup

#### Displays 2 lines, 16 characters

#### background lighting

#### Ambient air temperature 0 ... 45 ° C

#### Programmable flow parameters

#### Water Input 2x ¾ "

#### Introduction: DN 50

#### Outlet: DN 45

#### Super power: 220V AC

#### Chassis: S / S

#### Control Panel: PIC Integrated System

#### Heating: None

Hot Water Input

Cleaning tube input

Ma

Electric Connection Box

Cold

Vac

Water Out

Lid

Detergent pump

Electric Connections

Wall Connection

Water tank

ÖC.280 Vakumlu Yıkama Valf Grubu - Back flow & vacuum break



ÖC.281 Vakumlu Yıkama Panosu - Cleaning Control Box



Vakumlu Yıkama Manyetik Valfi - Vacuum Washing Magnetic Valve

ÖC.282 1/2"

ÖC.282-1 3/4"



ÖC.283 Vakumlu Yıkama Hortumu - Boilers Vacuumed cleaning Hose



Paslanmaz Yıkama Kazanları - Stainless Washer Tank

ÖC.231 100 Lt.

ÖC.231-1 150 Lt.

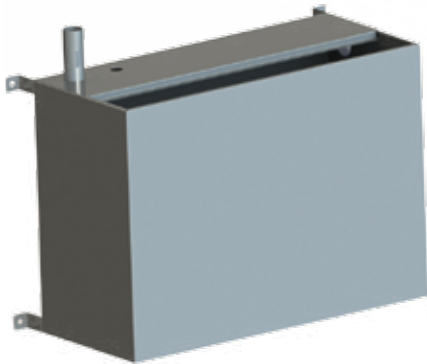

Plastik Yıkama Kazanları - Plastic Washer Tank

ÖC.231-2 100 Lt.





# Seyyar Makine Aksesuarları

Mobile Milking Machine Accessories

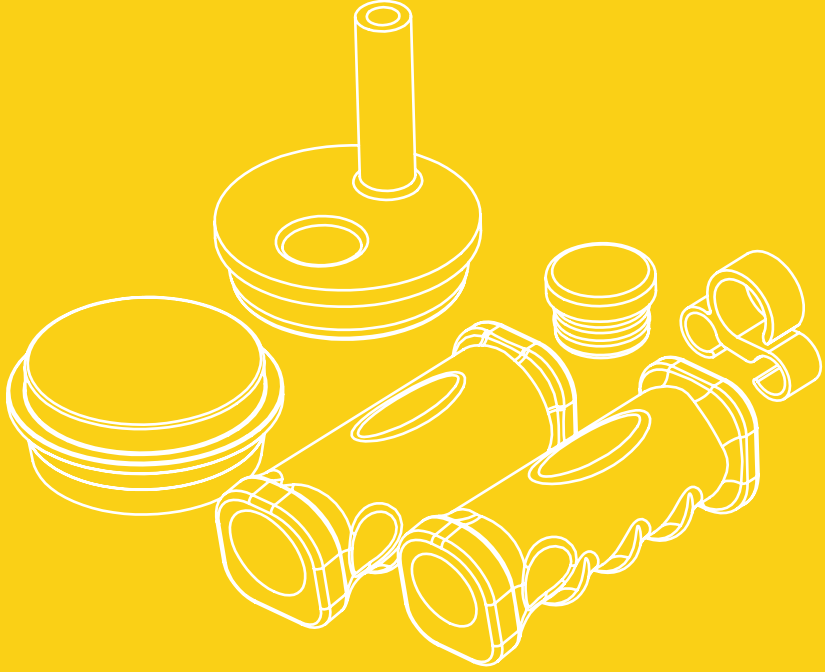



Süt Sađım Sektörünün olmazsa olmazı olan Makinelerin yedek parçaları, Tamiri ve bakımı esnasında kullanılmak üzere ihtiyaçlarımızı karşılıyoruz.

We Supply all spare parts for maintenance and repair operations of milking machines.



**En Uygun, En Kaliteli...**

**Best Available, Best Quality ...**

[www.oncelmak.com](http://www.oncelmak.com)



#oncelmakina

ÖC.053 Ø32 Ayak Lastiği  
Ø32 Stand Cover



• İsteğe bağlı farklı renkte üretilebilir.  
• Color may vary due to order

ÖC.053-3 Ø27 Ayak Lastiği  
Ø27 Stand Cover



• İsteğe bağlı farklı renkte üretilebilir.  
• Color may vary due to order

PVC Elcikler - PVC Handles

ÖC.060 Ø27

ÖC.060-1 Ø32



• İsteğe bağlı farklı renkte üretilebilir.  
• Color may vary due to order

ÖC.053-1 Ø27 Kauçuk Anten Tapası - Ø27 Rubber Chasis Plug

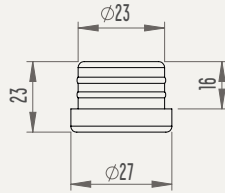

ÖC.191 Plastik T Hava Dağıtıcı - Plastic T Air Piece



ÖC.053-2 Ø32 Kauçuk Anten Tapası - Ø32 Rubber Chasis Plug

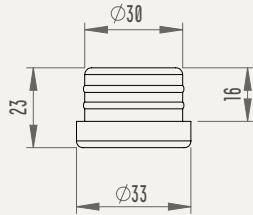

ÖC.128 Ø76 Kauçuk Boru Tapası  
Ø76 Rubber Tube Plug



ÖC.128-1 Ø76 Kauçuk Vidalı Boru Tapası  
Ø76 Rubber Tube Plug (Screwed)



ÖC.057 Hava Vana 1/2" - Ø16  
Air Valve 1/2" - Ø16

ÖC.057-1 Hava Vana 1/2" - Ø20  
Air Valve 1/2" - Ø20



ÖC.258-7 Metal Hava Vana 1/2" - Ø16  
Iron Air Valve 1/2" - Ø16



ÖC.057-2 Hava Vana - 2 Girişli  
Air Valve - 2 Entry



ÖC.168 Kapak Tapası  
Bucket Lid Plug

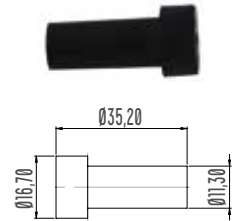

ÖC.061 Ø125 Döner Tekerlek - Pimli  
Ø125 Wheel

360°



ÖC.061-1 Ø125 Dönel Tekerlek - Tablalı  
Ø125 Wheel

360°



ÖC.144 Süt Stobu - Milk Stop



ÖC.285 Kablo Sarma Aparatı  
Cable Winding Apparatus



ÖC.062 Ø300x70 Ön Tekerlek  
Ø300x70 Front Wheel

Ø300



ÖC.062-1 Ø250x60 Ön Tekerlek  
Ø250x60 Front Wheel

Ø250



ÖC.287 Güğüm Saşe Pabuçu  
Bucket-Chassis Shock Absorber



ÖC.289 1Lt. Bidon Kapaksız  
1Lt. Bottle (Without Lid)





# Çiftlik Ekipmanları Livestock Equipment

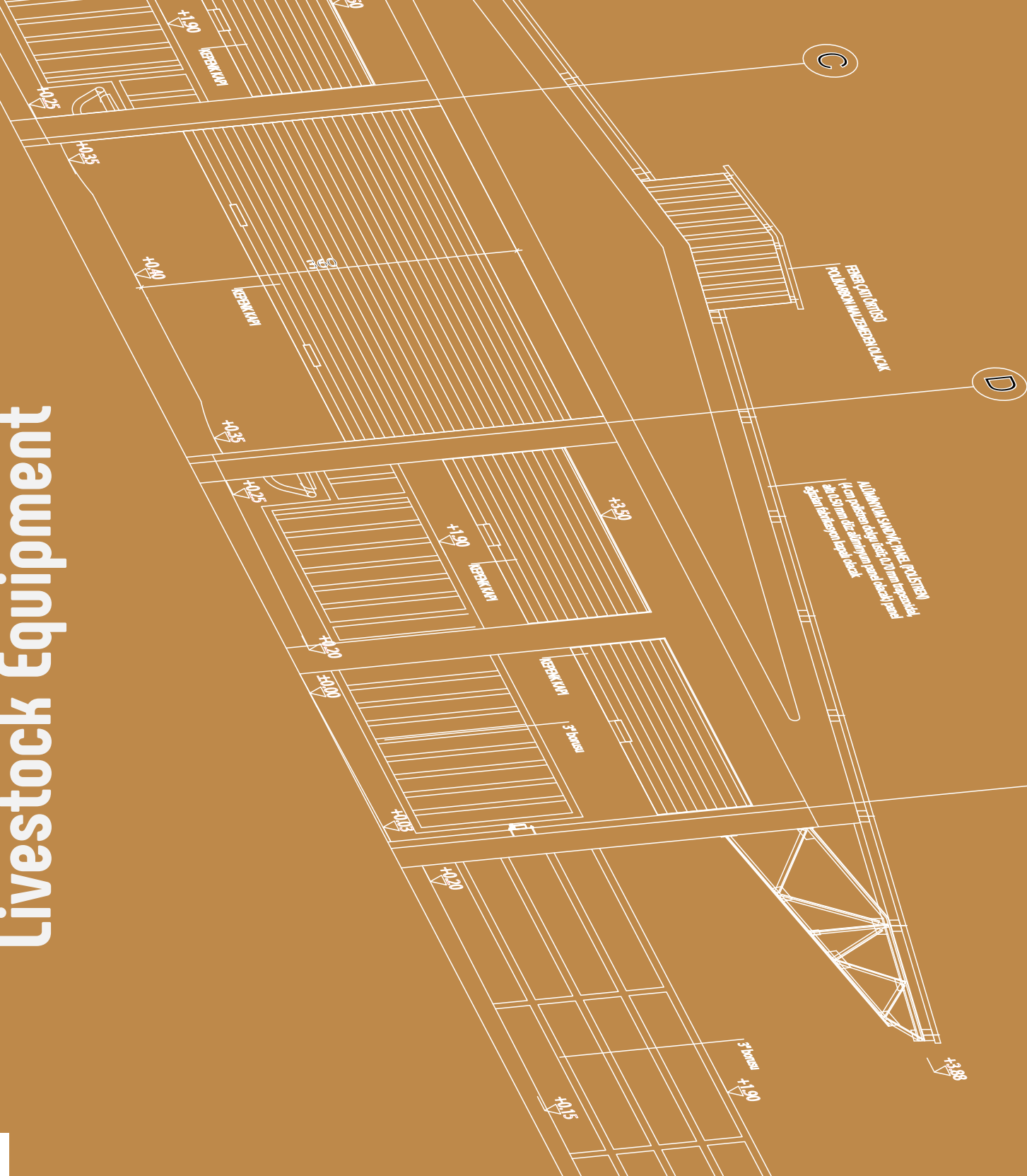

1/100 ölçekli teknik çizimdir.  
Çizim, yapıya göre yapılmıştır.  
Yapıya göre değişiklikler olabilir.  
Yapıya göre değişiklikler olabilir.

YERİNDEN YERİNE TAHSİS  
POLİMERİZASYONLU ZEMİN ÇUKURU





## Yapılabilecek en iyi seçim...

Kendi bünyemizdeki uzman ekibimizle etkin ve sürdürülebilir şekilde sonuç odaklı Çiftçilik teknolojisi portföyü hayvan beslemesi, ahır ekipmanı, ihtiyaçlarınıza cevap veriyoruz.

## The best choice...

We meet customer needs and expectations with our effective and result-oriented team and high-tech assortments.



**Kolaylık Portföyleri**  
**Convenience Portfolios...**

[www.oncelmak.com](http://www.oncelmak.com)



ÖC.055 Tekmesavar (Galvaniz Kaplı) - Anti Kick Bar (Galvanized)



Sağım esnasında hayvanların tekme atmasını önler ve farklı boyutlardaki hayvanlar için aralığı ayarlanabilir. Korozyona Karşı Çinko kaplama yapılmaktadır.

Safest and humane way to stop kicking cattle. Adjusted to any size animal. The material is covered with zinc.

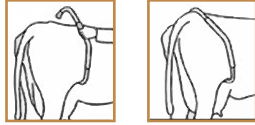

ÖC.187-1 Boyun Askı Numaratör Kayışı - Neck strap



Yerli üretim kayış ,Tokalı sistem kayış, 40 mm genişliğinde numaratorler için ideal ölçüdedir. Her tür ve kiloda hayvanın boynuna takılabilir. Numaratörler sıkışık durur. Hayvan çekmek için kullanılmaz.

Produced in Turkey belt, Token system belt, ideal for 40 mm wide numerators. Adjustable to any kind animal. The numbers stop cramped. Not used to draw animals.

En x Boy / Width x Length 125cmx3,5cm

ÖC.127 Plastik Burunsallık (Emme Engeleyici) - Plastic Noseband



İneklerin kendilerini emmelerini engellemek için yada buzağuların inekleri emmesini engellemek için kullanılmaktadır. Takılı iken yem yiyebilir ve su içebilirler.

Noseband provides an alternative to separating calves from their mothers and impede its ability to suck and reduce the stress of weaning. Calves can eat and drink while wearing a noseband



ÖC.064 Döküm Suluk - Molding Drinker



Ağırlık / Weight 6,4 kg  
Kapasite / Capacity 2,5 Lt.  
Darbelere karşı dayanıklı olup, Küçükbaş ve Büyükbaş için uygundur.  
Damage resistant and suitable for sheep, goats and cows.



ÖC.064-1

ÖC.187 Boyun Askı Numaratörü - ID-numbers



Her Numara Tek basamaklı ve Sarı renktedir. Boynuna kemer takılan tüm hayvanlar için kullanılmaktadır.

Made to fit a neck strap of 40 mm. wide, each number is available as an individual number and come in yellow color.

En x Boy / Width x Length :4,5cmx4,5cm

ÖC.067 Plastik Suluk - Plastic Drinker



Ağırlık / Weight 6,4 kg  
Kapasite / Capacity 2,5 Lt.  
Darbelere karşı dayanıklı olup, Küçükbaş ve Büyükbaş için uygundur.

Damage resistant and suitable for sheep, goats and cows.

ÖC.242 Paslanmaz Suluk - S/S Drinker



Ağırlık / Weight 6,4 kg

Kapasite / Capacity 2,5 Lt.

Darbelere karşı dayanıklı olup, Küçükbaş ve Büyükbaş için uygundur.

Available for sheep and goats, cows. Strong surface for any damages.

ÖC.079 Biberon 3 Lt. - Feeding Bottle 3 Lt.



ÖC.079-1 Biberon 2,5 Lt. - Bottle 2,5 Lt.



ÖC. 249 Donmaz Suluk - Frost-proof drinker



Kapasite / Capacity 110 Lt.

Donmaz Suluk -28 dereceye kadar etkilidir. 30 Adet büyükbaş kapasitelidir. Suyu dış ortama ile teması yoktur.

With the capacity of 25 Lt. it can satisfy up to 30 cows' water needs. Can be used in up to -28 degrees. It has 30 cattle capacity. Water does not come into contact with the external environment.

ÖC.085 Biberon (Geçmeli Komple)  
Feeding Bottle (Tongued Complete)ÖC.079-2 Kuzu Biberonu  
Feeding Bottle Lamb

ÖC.065 Suluk Subap - Drinker Valve



Prinç - Brass

ÖC.066 Suluk Keleçesi - Drinker Clamp

ÖC.082 Biberon Kabi 3 Lt.  
Feeding Bottle Cup 3 Lt.ÖC.080 Biberon Emziği Pasolu  
Feeding Bottle Nipple Screw Cover

ÖC.065-1 Suluk Subap Tamir Takımı - Drinker Valve Repair Set

ÖC.081 Biberon Pasosu  
Feeding Bottle Screw CoverÖC.083 Geçmeli Biberon Emziği  
Feeding Bottle Nipple Tongued

ÖC.172-1 Kuzu Kovası (5 Emzikli) - Lamb Feeder (5 Teats)



Ağırlık / Weight 6,4 kg  
Kapasite / Capacity 2,5 Lt.  
Buzağı beslenmesi için buzağı emzirme kovası Kırmızı buzağı emzik ve valf ile birlikte tam takım olarak sunulmaktadır.

Calf breast feeding kit for calf feeding Red calf is available as a full suite with teat and valve.

ÖC.172-2 Kuzu Kovası (3 Emzikli) - Lamb Feeder (3 Teats)



Ağırlık / Weight 6,4 kg  
Kapasite / Capacity 2,5 Lt.  
Buzağı beslenmesi için buzağı emzirme kovası Kırmızı buzağı emzik ve valf ile birlikte tam takım olarak sunulmaktadır.

Calf breast feeding kit for calf feeding Red calf is available as a full suite with teat and valve.

ÖC.171 Buzağı Kovası (Tek Emzik) - Calf Feeder

ÖC.171-5 Buzağı Kovası (İki Emzik) - Two Calf Feeder

ÖC.172-5 Buzağı Kovası (Üç Emzik) - Three Calf Feeder

ÖC.172-6 Buzağı Kovası (Beş Emzik) - Five Calf Feeder



Ağırlık / Weight 6,4 kg  
Kapasite / Capacity 2,5 Lt.  
Buzağı beslenmesi için buzağı emzirme kovası Kırmızı buzağı emzik ve valf ile birlikte tam takım olarak sunulmaktadır.

Calf breast feeding kit for calf feeding Red calf is available as a full suite with teat and valve.

ÖC.172 Kuzu Kovası (6 Emzikli) - Lamb Feeder (6 Teats)



Ağırlık / Weight 6,4 kg  
Kapasite / Capacity 2,5 Lt.  
Buzağı beslenmesi için buzağı emzirme kovası Kırmızı buzağı emzik ve valf ile birlikte tam takım olarak sunulmaktadır.

A set of nipples and valves to complete the grey bucket.

ÖC.171-3 Kova Valf Conta Feeder Valve Gasket



ÖC.171-4 Kova Askı Aparatı Bucket Hanger



ÖC.172-3 Kuzu Kova Emziği Lamb Feeder Nipple



ÖC.172-4 Kuzu Kova Emziği (Pratik) Lamb Feeder Nipple (Practical)



ÖC.081-1 Kuzu Biberon Pasosu Feeding Bottle Lamb Cover



ÖC.171-2 Kova Valfi - Feeder Valve



ÖC.084 Kuzu Biberon Emziği Feeding Bottle Nipple Lamb



ÖC.171-1 Kova Emzik (Buzağı) Feeder Nipple (Calf)



ÖC.221 Elektrikli Çit Cihazı -Shock Device (Yabani Hayvan - Wild Animal)

ÖC.221-1 Elektrikli Çit Cihazı -Shock Device (Evcil Hayvan - Pet)



Yabani Hayvan - Wild Animal



Evcil Hayvan - Pet

ÖC.224 İzolatör - Isolator



ÖC.226 Kapı Kolu Seti - Door Handle Set



ÖC.222 Güneş Enerjili Çit Cihazı (Yabani Hayvan) - Solar Panel Shock Device (Wild Animal)

ÖC.222-1 Güneş Enerjili Çit Cihazı (Evcil Hayvan) - Solar Panel Shock Device (Cow,Goat,Sheep,etc)

ÖC.222-2 Güneş Enerjili Çit Cihazı (Evcil Hayvan) - Solar Panel Shock Device (Cow,Goat,Sheep,etc)

ÖC.222 7,2 A / 10 W

ÖC.222-1 14 A / 20 W

ÖC.222-2 20 A / 40 W



ÖC.225 120cm Plastik Direk - 120cm Plastic Pole



Taşınabilir plastik direk 120 cm boyundaki bu direkler kolay montajı yapılıır.

Portable plastic pillar These pillar with 120 cm height are easy to install.

ÖC.223 Çit İpi - Fence Rope (500 mt.)

ÖC.223-1 Çit İpi - Fence Rope (250 mt.)

ÖC.223-2 Çit İpi - Fence Rope (1000 mt.)



ÖC.227 Akü Şarj Cihazı - Battery Charger



Her türlü kuru veya sulu akü şarjı için.  
Led göstergeli  
Kısa devre korumalı

For any kind of dry or aqueous battery charge.  
LED indicator  
Short-circuit protected

ÖC.248-1 Krema Seperatörü (Yoğurt İçin) - Cream Seperator (For Yogurt)



Enerji Tüketimi  
Power Consumption :40 Watt  
Kapasite 15 dakikada 3kg Yoğurt 300gr Krema  
Capacity 15 Minutes 3 Kg Yogurt 300 gr Krema  
Haznesi Kapasitesi  
Storage Capacity :5 Lt. / Alüminyum  
Akım Girişi  
Current Input :220V / 50-60 Hz

ÖC.248 Krema Makinesi - Cream Seperator



Enerji Tüketimi  
Power Consumption :60 Watt  
Kapasite :1 saat 100 lt Süt Çekme  
Capacity :1 hour 100 lt Dairy Extraction  
Süt Haznesi Kapasitesi  
Milk Storage Capacity:10 Lt. / Alüminyum  
Akım Girişi  
Current Input :220V / 50-60 Hz  
Tambur Devri  
Tambour Revolt :10500+- / 1000 d/dk.  
Yükseklik / Height :52 cm  
Ağırlık / Weight :5,6 kg

ÖC.243 Kaşınma Fırçası- Automatic itch brush



ÖC.243-2 Fırça Kartı  
Itch Brush Card

Özellikler - Features

Uzunluk/ Height 130 cm  
Genişlik/ Widht 135 cm  
Fırça Uzunluğu/Brush Length 72 cm  
Fırça Çapı/Brush Diameter Ø 46 cm  
Net Ağırlık/Net Weight 56 kg  
Brüt Ağırlık/Gross Weight 60 kg  
Motor Gücü/Engine Power 0,18 kW  
Voltaj - Frekans/Voltage 220V-50 Hz  
Dönüş Hızı/Rotation Speed 30 dev/dak (rpm)  
Paket Ebatları  
Package Dimensions 130 / 60 / 40

ÖC.243-1 Yedek Fırça  
Spare Itch Brush

Hayvan Yatağı- Livestock mat

ÖC.244 110x190 (22mm)

ÖC.244-A 120x190 (22mm)

ÖC.244-1 110x190 (20mm)

Oluklu kauçuk büyükbaş hayvan altlıkları özel yapısı ile zararlı sıvıları besi hayvanlarınızdan uzak tutar. Ayrıca geçirgendir, sıvıyı alt tabakaya ileterek kuru bir zemin sağlar.

Our corrugated rubber matting products are excellent for protecting livestock from the hard concrete, improving and providing a non-absorbent and slip resistant environment. The mats will keep them safe and comfortable, and as a result productive.

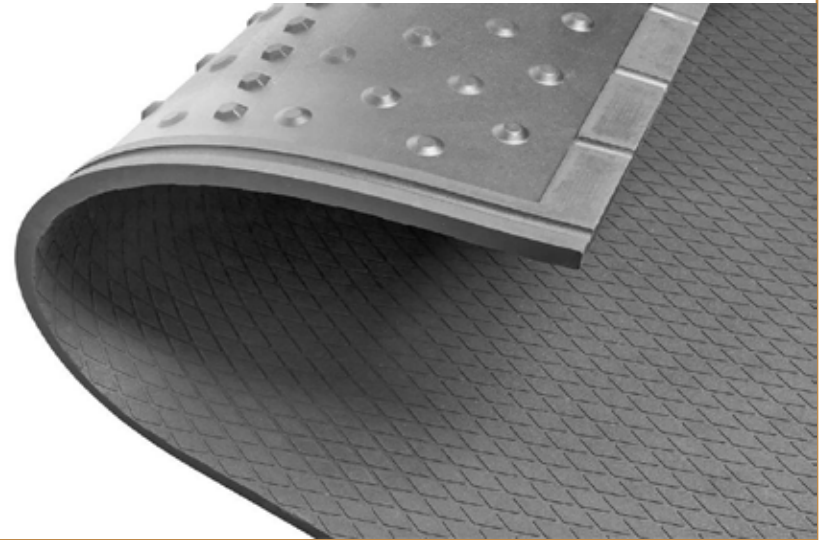

## Hamur Karma Makinesi - Dough Kneading Machines

ÖC.245	10 Kg - 220V - 0,37Kw
ÖC.245-1	15 Kg - 220V/380V - 0,37Kw
ÖC.245-2	25 Kg - 220V/380V - 0,55Kw
ÖC.245-3	35 Kg - 220V/380V - 0,75Kw
ÖC.245-4	50 Kg - 220V/380V - 1,1 Kw



Karıştırma çatalı sayesinde hamuru ısıtmadan ve özelliğini bozmadan yoğurur. Gıdanın temas ettiği noktalar paslanmaz çelikten imal edilmiştir. Kazan ve hareketli çatal sayesinde pratik temizlik imkanı ve hamuru kazan ile götürme imkanı sağlar. Titreşimsiz çalışma Gövdede özel tutma yerleri sayesinde taşıma kolaylığı.

With the spiral and bowl shaped machine, proper mixture can be achieved in a relatively short period of time regardless of the amount. It doesn't cause to become warm if used properly. Parts that come in contact with dough are made of stainless steel which allows easy cleaning. Works with no vibration and has a handle which allows an easy pick up.

## Yayık Makinesi - Churning machine

ÖC.246-3	10 Lt. Kapasiteli / Capacity
ÖC.246	20 Lt. Kapasiteli / Capacity
ÖC.246-4	35 Lt. Kapasiteli / Capacity
ÖC.246-5	40 Lt. Kapasiteli / Capacity
ÖC.246-1	45 Lt. Kapasiteli / Capacity
ÖC.246-2	55 Lt. Kapasiteli / Capacity



El ile kolayca sökülüp temizlenebilen pervane sistemine sahiptir. Komple paslanmaz çelik gövdedir. Tahliye borusuna Sahip ve 220V - 200 Watt - 50/60 Hz Elektrik motoru ile çalışır.

It has a propeller system that can be easily removed and cleaned by hand. The body is a stainless steel body. Has a discharge pipe and works with 220V - 200 Watt - 50-60 Hz electric motor.

## Havalandırma Fanı - Ventilation Fan

ÖC.247	140x140 (220V - 1,1Kw)
ÖC.247-1	140x140 (220V - 0,55Kw)
ÖC.247-2	100x100 (220V - 1,1 Kw)
ÖC.247-3	100x100 (220V - 0,55Kw)

140x140 - 100x100 Sirkülasyon Fanları, kayış kasnaklı ve yandan motorludur. Kanatlar galvanizli çelik sacdan üretilmektedir.

Tavuk çiftliklerinde, barınaklarda, kümeslerde, atelyelerde, mantarhanelerde, fabrikalarda, üretim alanlarında, açık havalarda, egsoz ve sirkülasyon amaçlı kullanıma uygundur.

Fans keep your barn cool with the proper exhaust or circulation fans. Our fans are great to eliminate condensation, helping to deliver maximum airflow over wide areas.

100X100



140X140



ÖC.288 Doğum Arabası - Calf Pulling & Carrying Trolley



Kapalı Uzunluk - Closed Length: 150 cm

Genişlik -Width: 36 cm

Kalça desteği açıklığı : 40 cm

- \*Büyükbaş Doğum Arabası, Doğuma yardımcı inek doğum krikosu'dur.
- \*Kayış uçları buzağının ayağına kement yapılarak kullanılır, inek doğurmak üzereyken teker çevrilerek kullanılır.
- \*Ürün üzerindeki kilit sistemi, tekerin geri dönmesini önlemek içindir.
- \*Tek kişinin basitçe kullanabileceği şekilde tasarlanmıştır.
- \*Büyükbaş Hayvanınız, Ayakta ya da yatıyor olduğu her iki durumda da kullanılabilir.

Our corrugated rubber matting products are excellent for protecting livestock from the hard concrete, improving and providing a non-absorbent and slip resistant environment. The mats will keep them safe and comfortable, and as a result productive.





Hortumlar - Hoses

Sağım Başlığı ve Aksesuarları  
Milking Cluster and Accessories



Seyyar Makine Aksesuarları  
Mobile Machine Accessories

Seyyar Makine Aksesuarları  
Mobile Machine Accessories

Güğümler ve Aksesuarları  
Buckets and Accessories

Vakum Pompaları ve Aksesuarları  
Vacuum Pump and Accessories

Sağım Sistemi Aksesuarları  
Milking Systems Accessories

Vakum Pompaları ve Aksesuarları  
Vacuum Pump and Accessories

Sağım Sistemi Aksesuarları  
Milking Systems Accessories

Vakum Pompaları ve Aksesuarları  
Vacuum Pump and Accessories

Sağım Sistemi Aksesuarları  
Milking Systems Accessories

Güğümler ve Aksesuarları  
Buckets and Accessories

Uygunluk Kılıfları  
Milking Systems Accessories

Vakum Pompaları ve Aksesuarları  
Vacuum Pump and Accessories

Pulsatörler - Pulsators

Güğümler ve Aksesuarları  
Buckets and Accessories

Hortumlar - Hoses

Güğümler ve Aksesuarları  
Buckets and Accessories

Sağım Sistemi Aksesuarları  
Milking Systems Accessories

Sağım Sistemi Aksesuarları  
Milking Systems Accessories

Süt Lastikleri - Milking liners

Milking liners

Sağım Sistemi Aksesuarları  
Milking Systems Accessories

Hortumlar - Hoses

Pulsatörler - Pulsators

Sağım Sistemi Aksesuarları  
Milking Systems Accessories

Hortumlar - Hoses

Buckets and Accessories

Sağım Sistemi Aksesuarları  
Milking Systems Accessories

Çiftlik Ekipmanları  
Livestock Equipments

Güğümler ve Aksesuarları  
Buckets and Accessories

Sağım Sistemi Aksesuarları  
Milking Systems Accessories

Pulsatörler - Pulsators

Vakum Pompaları ve Aksesuarları  
Vacuum Pump and Accessories

Sağım Sistemi Aksesuarları  
Milking Systems Accessories

Seyyar Makine Aksesuarları  
Mobile Machine Accessories

Süt Lastikleri - Milking liners

Sağım Sistemi Aksesuarları  
Milking Systems Accessories

Vakum Pompaları ve Aksesuarları  
Vacuum Pump and Accessories

Milking Cluster and Accessories

Sağım Sistemi Aksesuarları  
Milking Systems Accessories

Vakum Pompaları ve Aksesuarları  
Vacuum Pump and Accessories

Sağım Başlığı ve Aksesuarları  
Milking Cluster and Accessories

Sağım Sistemi Aksesuarları  
Milking Systems Accessories



Sağım Sistemi Parçaları & Hayvancılık Ekipmanları  
Milking System Parts & Livestock Equipment

"Öncel ile Öncelikli olun" - "Be Privileged With Öncel"

Fabrika / Factory : Yalıntaş Mah. 534.Sokak No: 13  
Mustafa Kemal Paşa / Bursa / TÜRKİYE



+90 224 614 12 50-57

+90 850 219 77 50



#oncelmakina

[www.oncelmak.com](http://www.oncelmak.com) - [oncel@oncelmak.com](mailto:oncel@oncelmak.com)



2022/08